

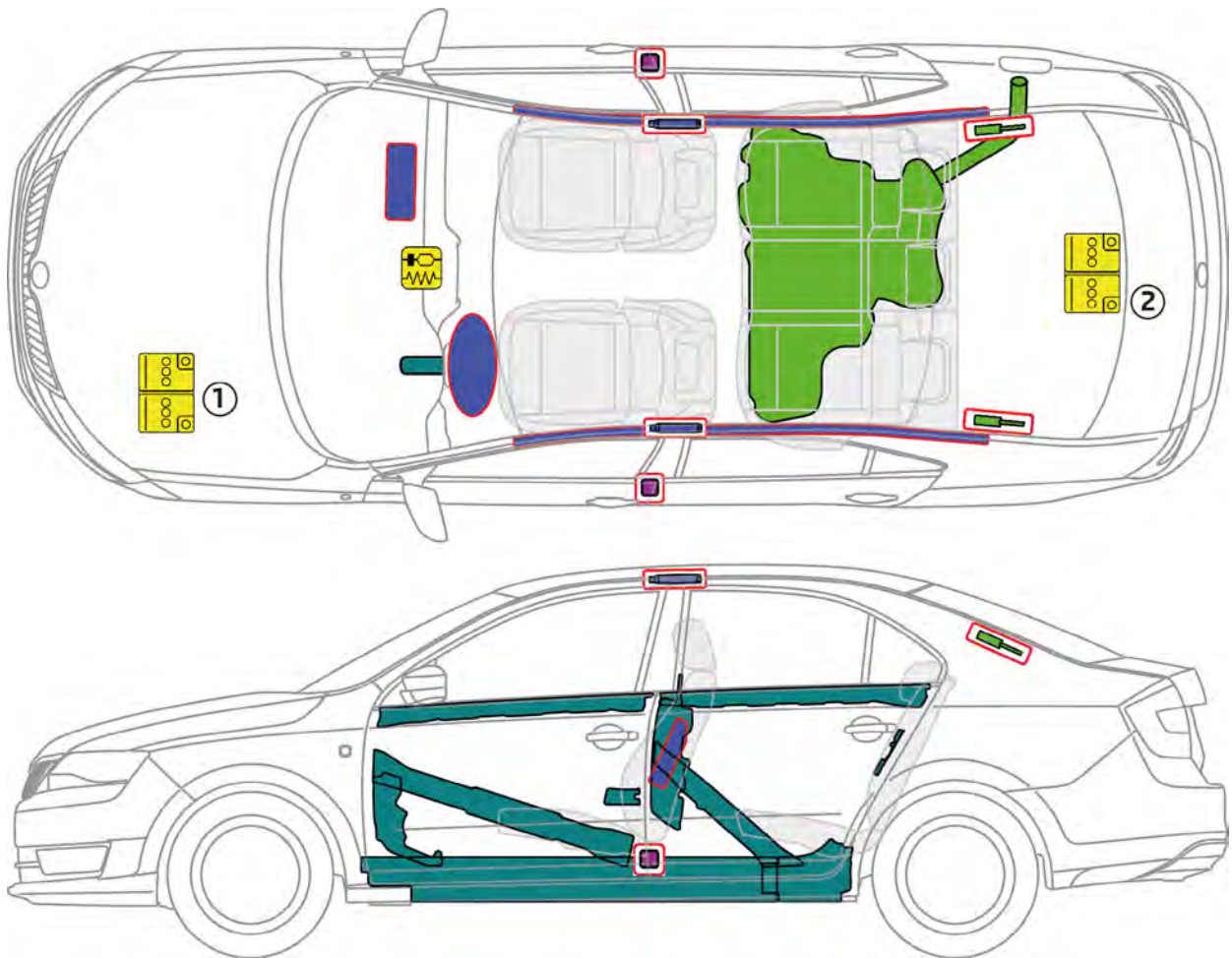









ŠKODA RAPID (ab 2012)

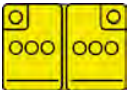

① alle Fahrzeuge, außer Motorisierung 1,6 I/85 kW TDI CR

② alle Fahrzeuge, mit Motorisierung 1,6 I/85 kW TDI CR

Legende

	Airbag		Karosserie-Verstärkung		SRS Steuergerät
	Niedervolt-Batterie		Gasgenerator		Gasdruckdämpfer / vorgespannte Feder
	Treibstofftank		Gurtstraffer		
		ID-Nummer	Versionsnummer	Versionsdatum	Seite
		TMB- NH	01	02/2016	26