

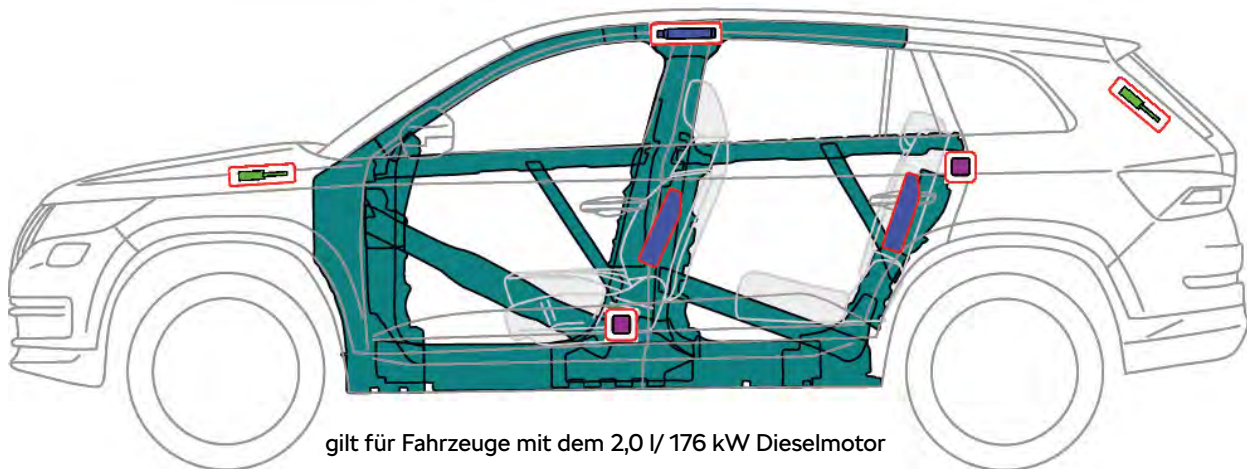

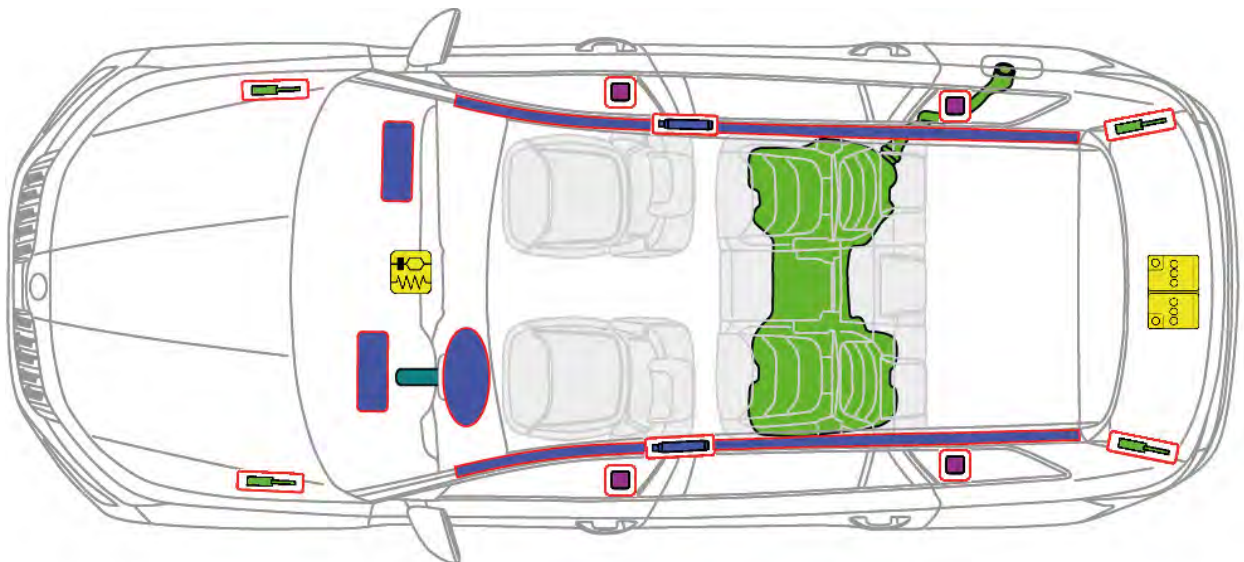







ŠKODA KODIAQ RS (ab 2018)

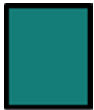

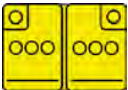
gilt für Fahrzeuge mit dem 2,0 l / 176 kW Dieselmotor

Legende

	Airbag		Karosserie-Verstärkung		SRS Steuergerät	
	Niedervolt-Batterie		Gasgenerator		Gasdruckdämpfer / vorgespannte Feder	
	Treibstofftank		Gurtstraffer			
			ID-Nummer	Versionsnummer	Versionsdatum	Seite
			TMB- NS	04	10/2019	37