

















	Airbag		Gas-generator		Gurtstraffer		SRS-Steuergerät		Aktives Fußgänger-schutz-system
	Auto-matischer Überroll-schutz		Gasdruck-feder/ vor-gespannte Feder		Hochfester S-tahl		Zone, die besondere Aufmerksamkeit erfordert		
	Nieder-spannungs-batterie		Ultra-kondensator , Nieder-spannung		Kraftstoff-tank		Gastank		Sicherheits-v-entil
	Hochvolt-batteriepac-k		Hochvolt-kabel/ -teil		Notfall-trennstelle		Sicherung/ Abschalten der Hoch-spannung		Ultra-kondensator , Hoch-spannung

# 1. Identifizierung / Erkennung



\* Nur für die N-Line Ausstattungsvariante

# 2. Immobilisieren / Stabilisieren / Anheben

## ■ Immobilisation



Handbremse so weit wie möglich anziehen

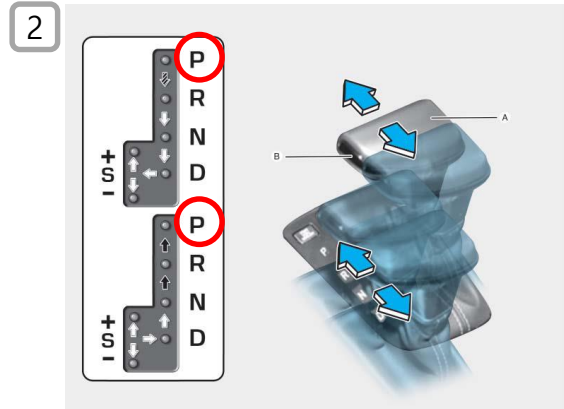

Bei Fahrzeugen mit Automatikgetriebe: Wählhebel in Position P bringen

## ■ Hebepunkte am Fahrzeugboden: ●

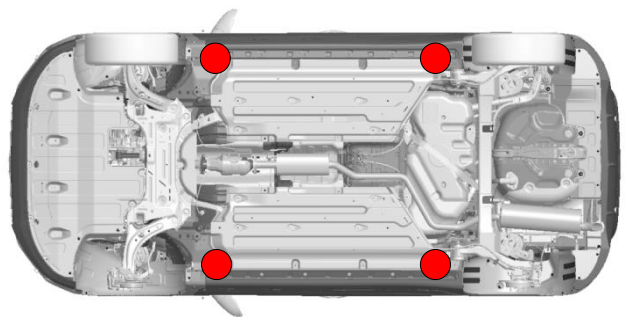
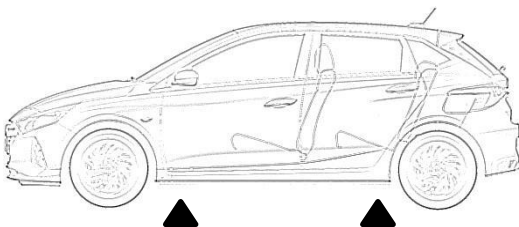

	ID Nr.	Versionsnr.	Versionsdatum	Seite
	NLH-BC3-RSI-01-202104	01	04/2021	2 of 4

### 3. Direkte Gefahren ausschalten / Sicherheitsbestimmungen

#### ■ Zugang zur Batterie

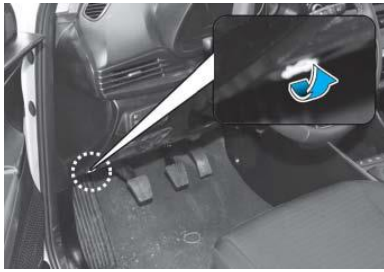
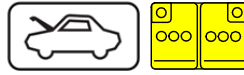

Ziehen Sie den Entriegelungshebel an, um die Motorhaube zu entriegeln. Die Haube sollte leicht aufspringen

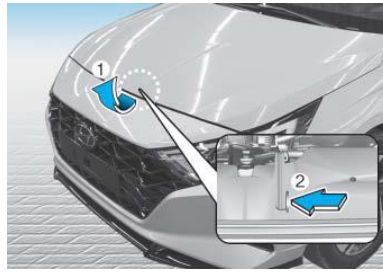

Heben Sie die Haube leicht an, drücken Sie den Fanghaken innen in der Mitte (1) nach oben und öffnen Sie die Haube (2).

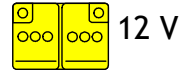

#### ■ Deaktivierung

① Zündung ausschalten



② Minuspol (-) abklemmen



③ Pluspol (+) abklemmen

### 4. Zugang zu den Insassen

#### ■ Glas

1 : Verbundglas

2-5 : Gehärtetes Glas



#### ■ Karosserie

Gehärteter Stahl

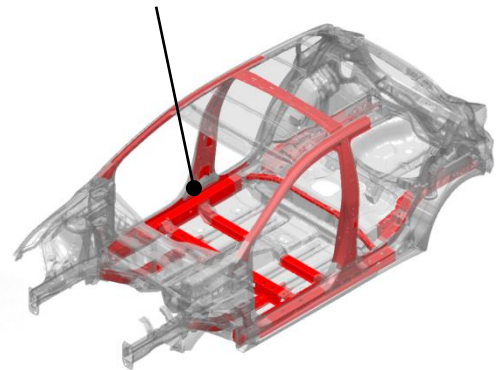

### 5. Gespeicherte Energie / Flüssigkeiten / Gase / Farnstoffe

#### ■ Kraftstofftank

40ℓ

#### ■ Batterie



12 V

	ID Nr.	Versionsnr.	Versionsdatum	Seite
	NLH-BC3-RSI-01-202104	01	04/2021	3 of 4

## 6. Im Brandfall

### ■ Gasdruckfeder

- Durch Hitzeentwicklung in den Gasdruckfedern besteht ein Risiko, dass die Heckklappe unkontrolliert hochschnellt.

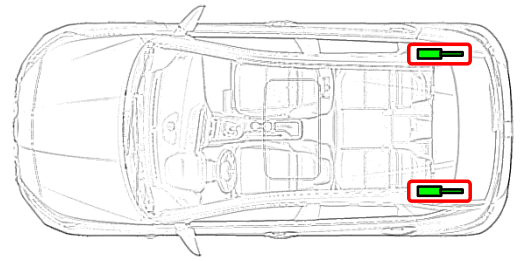

## 8. Abschleppen / Transport / Lagerung

### ■ OK

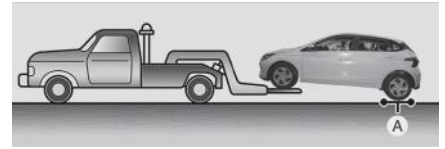
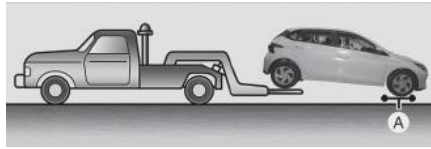
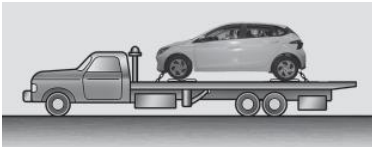

[A] : Nachläufer

### ■ NICHT OK



	ID Nr.	Versionsnr.	Versionsdatum	Seite
	NLH-BC3-RSI-01-202104	01	04/2021	4 of 4