

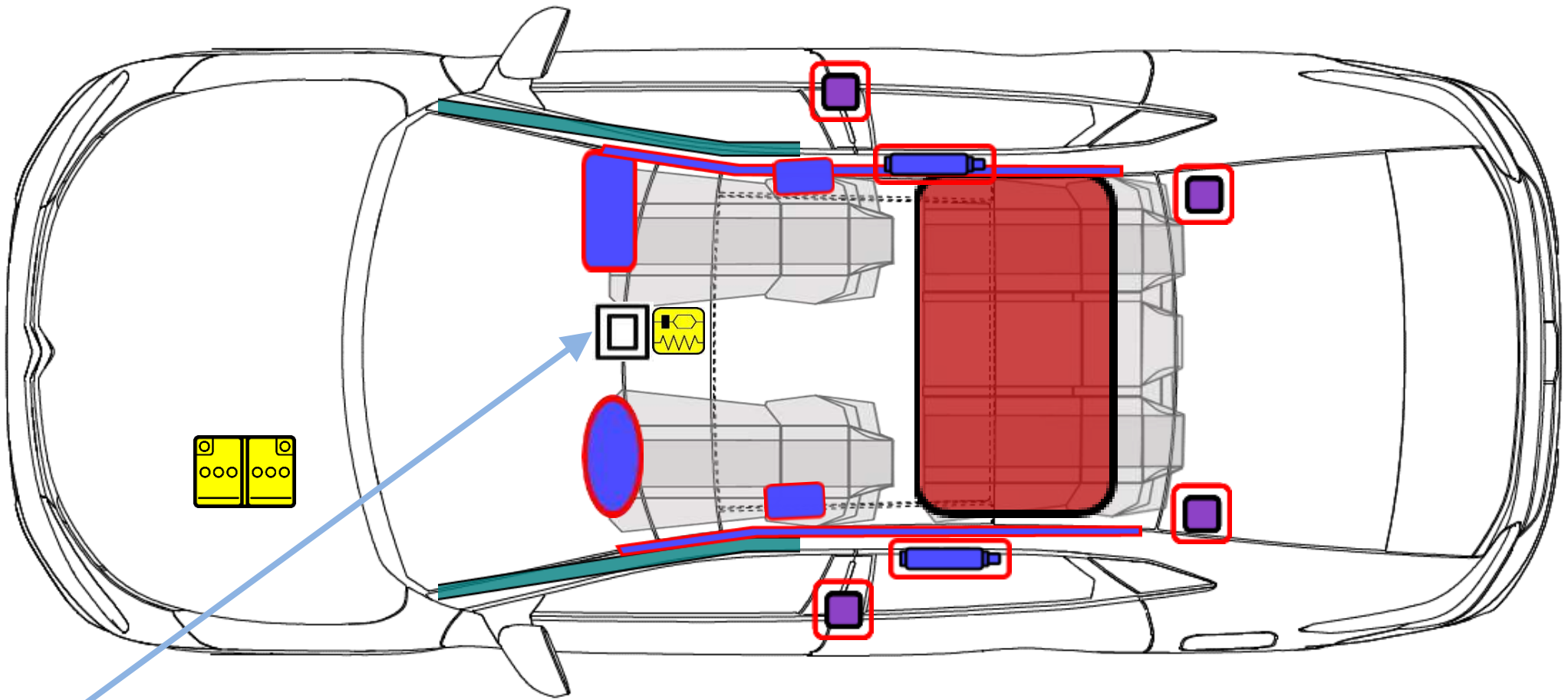

Citroën C4 X

4 Türen/ 5 Sitzplätze/ Limousine
(2022/ ->)



9.

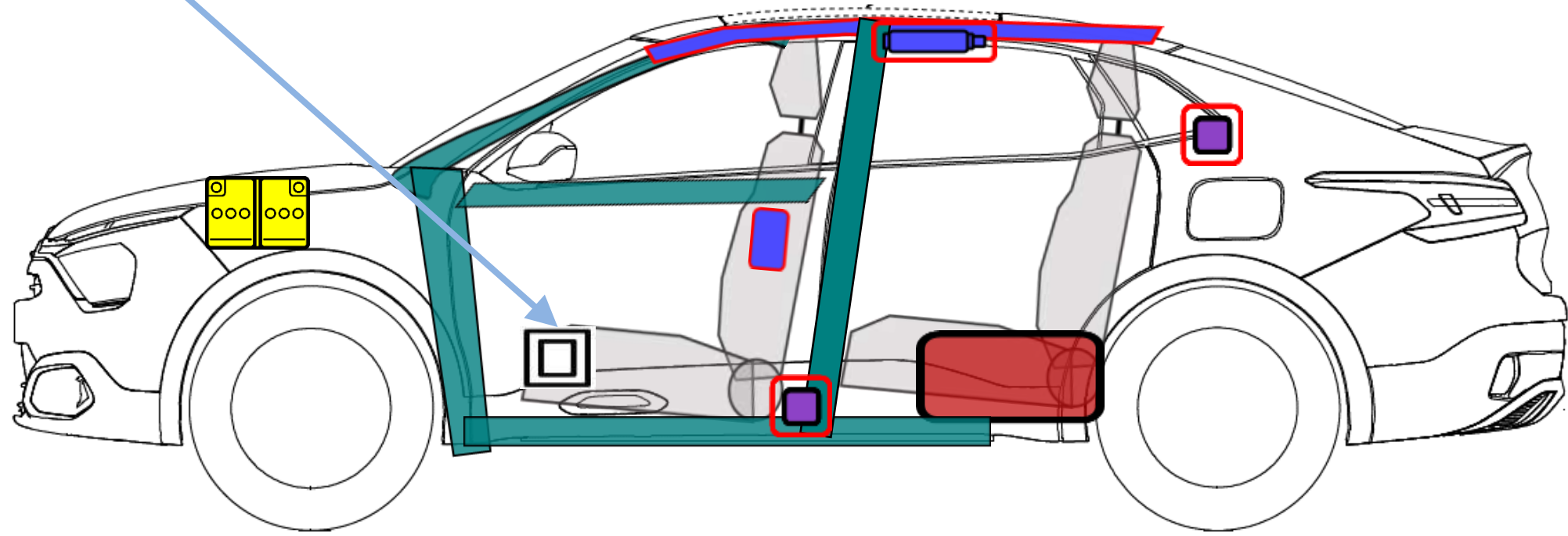

	Airbag		Gasgenerator		Gurtstraffer		SRS Steuergerät		
					Karosserie-Verstärkung		Bereich Bedarf besonderer Aufmerksamkeit		
	Niedervolt-Batterie								
					Benzin-/Ethanol-Kraftstofftank				

1. Identifizierung / Erkennung

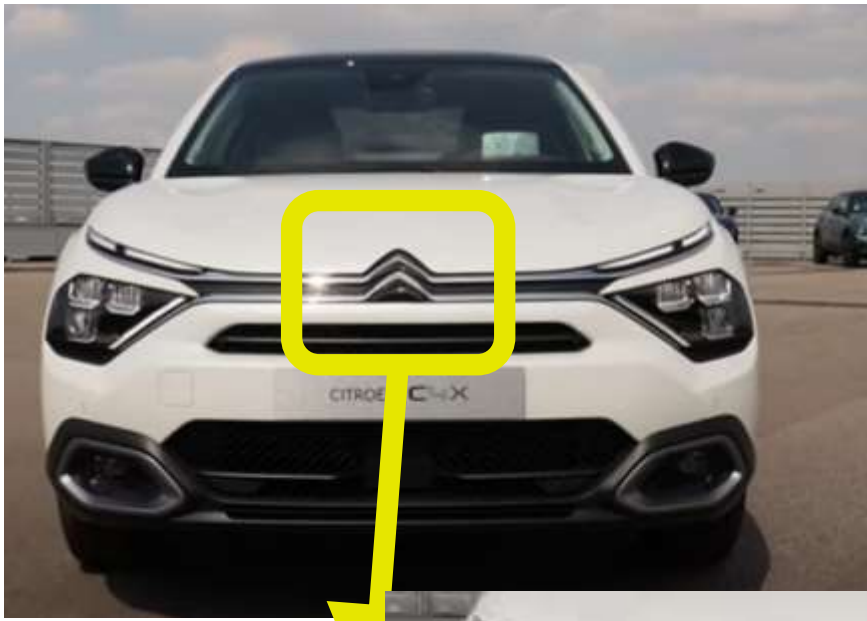

Markenlogo

Modellname

2. Immobilisieren / Stabilisieren / Anheben

Unbeweglichkeit

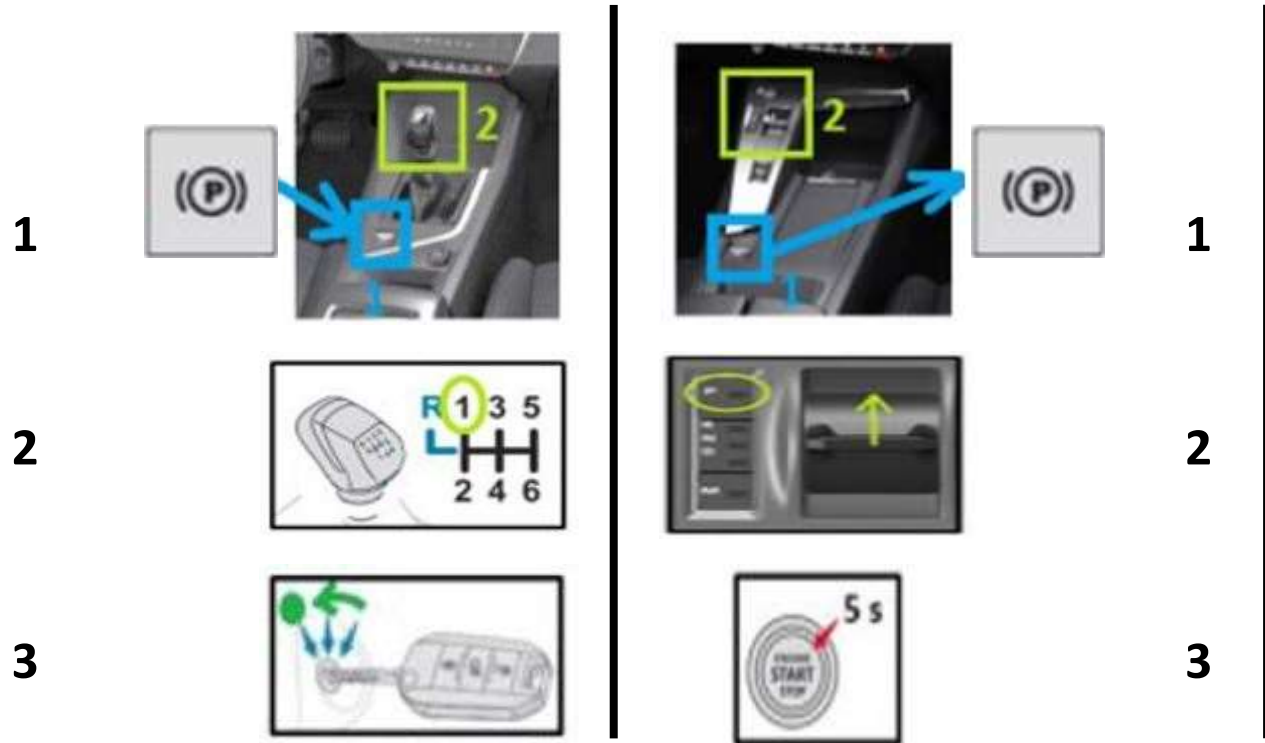

Stabilisierungs-/Hebepunkte

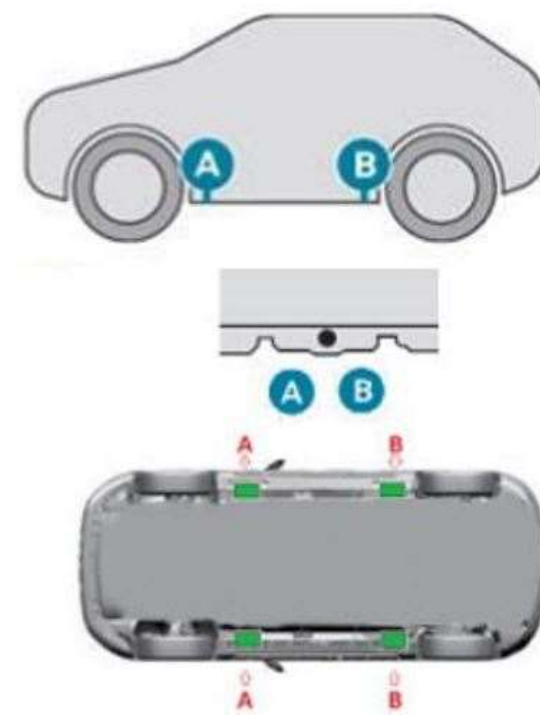

3. Direkte Gefahren ausschalten / Sicherheitsbestimmungen

Hauptdeaktivierungsmethode

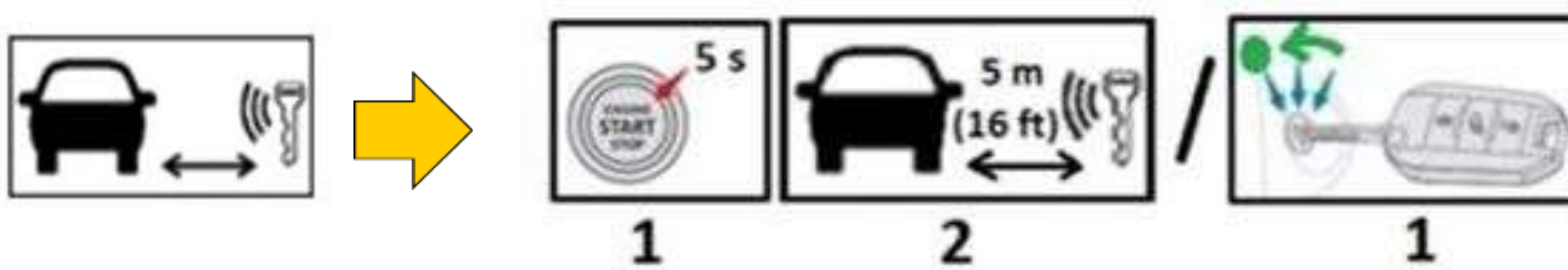

12 Volt Batterie abklemmen

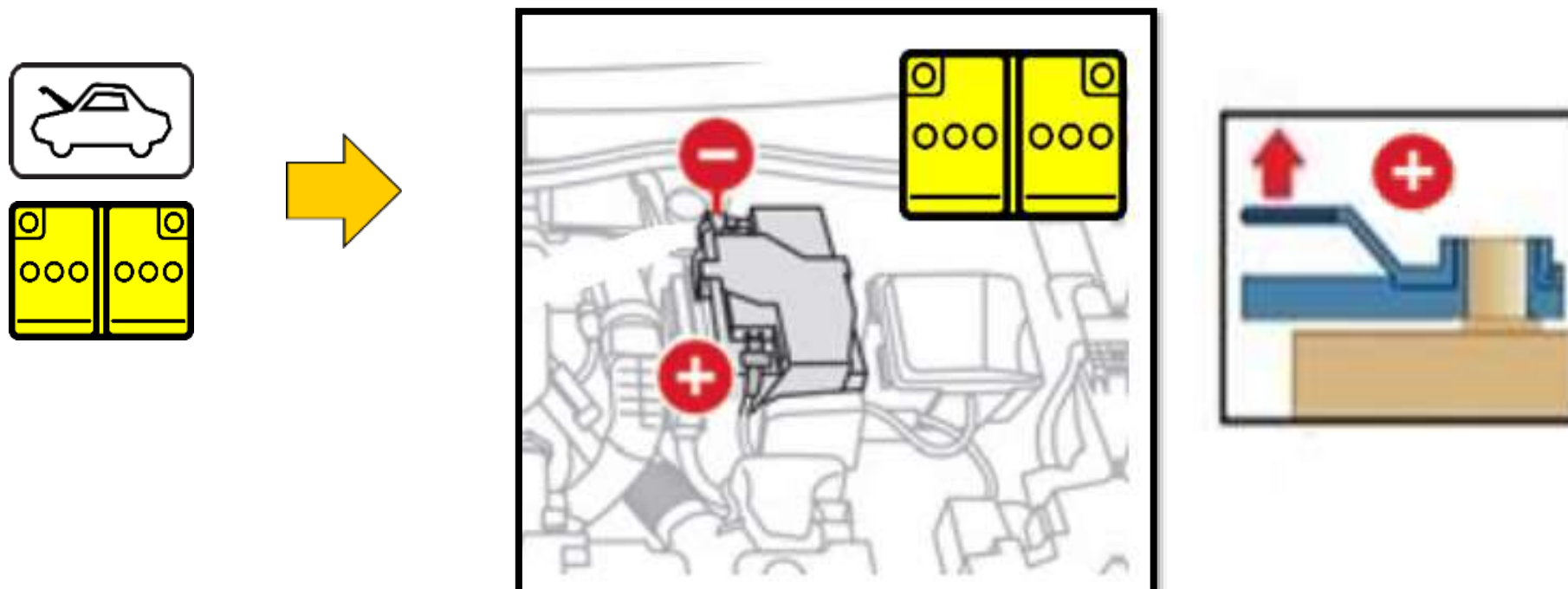

4. Zugang zu den Insassen

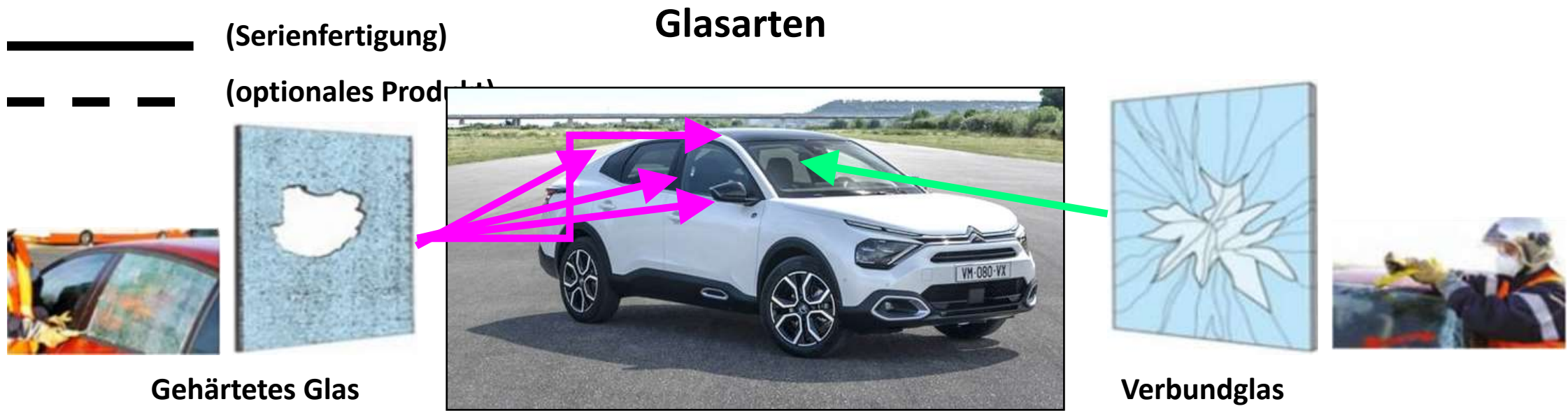

Körper aus hochfestem Stahl

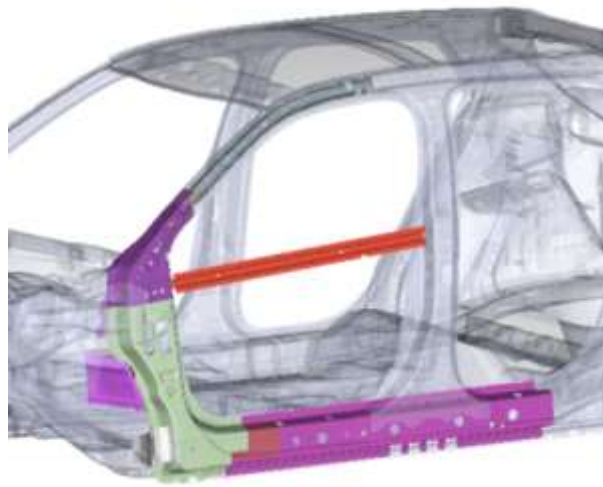

Sitzverstellung

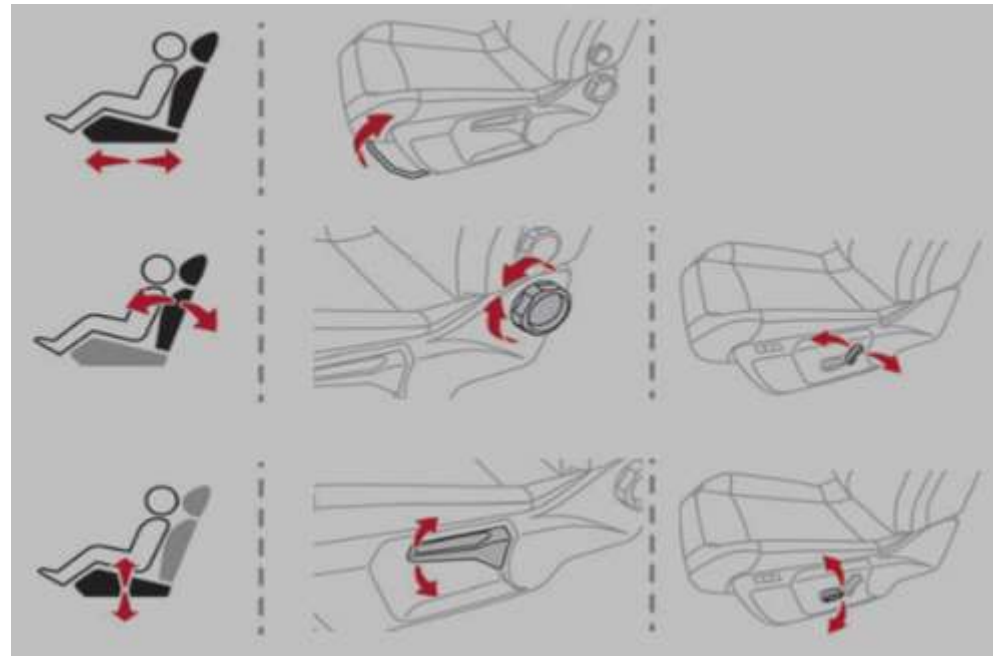

Lenksäulenverstellung

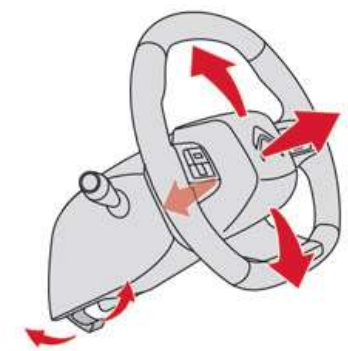

5. Gespeicherte Energie / Flüssigkeiten / Gase / Feststoffe

	12V	
	50L	

8. Abschleppen / Transport / Lagerung

Position vorderer Haken

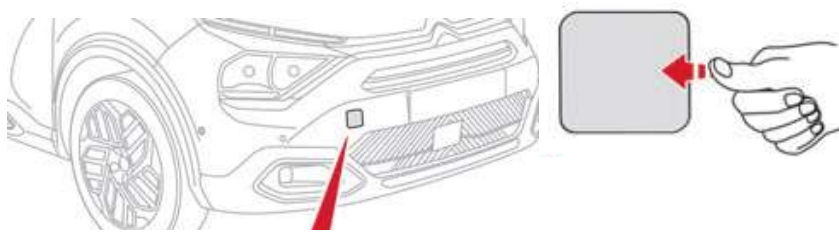

Position hinterer Haken

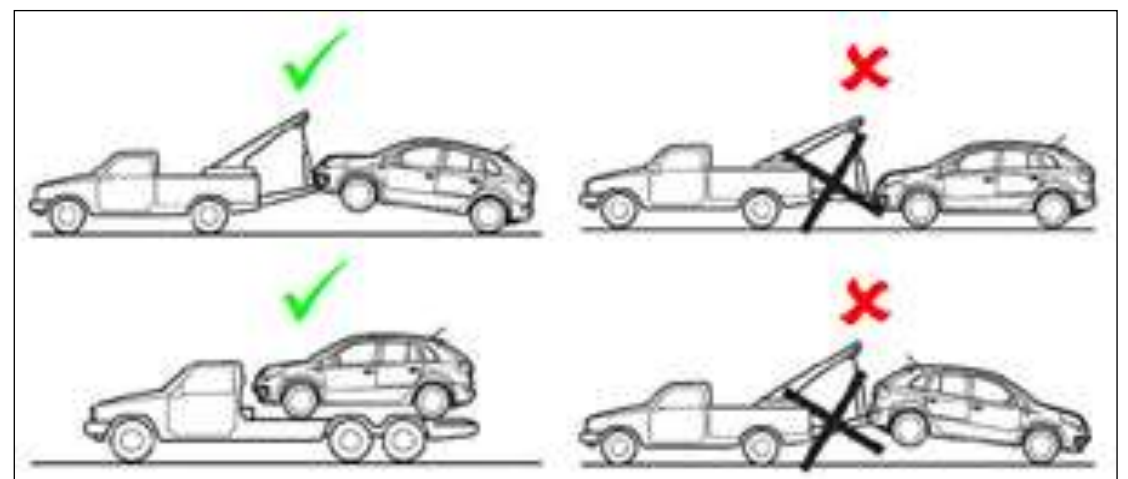
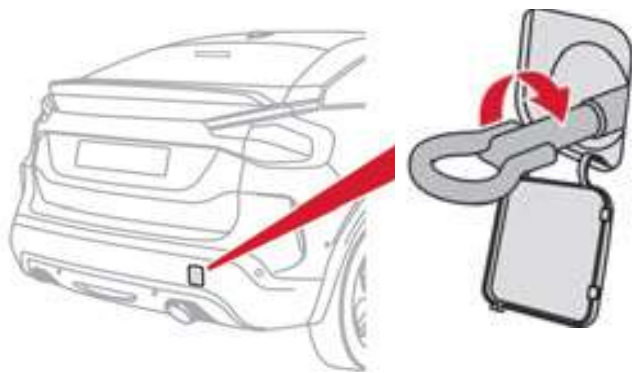

9. Wichtige zusätzliche Informationen

