



# Rettungsdatenblätter

Diese Rettungsdatenblätter dienen ausschließlich Einsatzkräften auf dem Gebiet der technischen Hilfeleistung.

Alle auf den Rettungsdatenblättern enthaltenen Informationen sind ausschließlich für Fahrzeuge, welche für den europäischen Markt bestimmt sind. In den Rettungsdatenblättern ist immer die maximal mögliche Ausstattung der Fahrzeuge gezeigt.

Rechtsgelenkte Fahrzeuge können Bauart bedingt abweichen.

Fahrzeuge und Ausstattungsvarianten unterliegen ständigen Änderungen. KIA behält sich das Recht vor, Konstruktionen und Spezifikationen jederzeit ohne Ankündigung und ohne Übernahme eine Verpflichtung auslaufen zu lassen oder zu ändern.

**Hinweis:**

**Diese Informationen sind ausschließlich für geschulte Einsatzkräfte und nicht für Endkunden, Werkstätten und Händler bestimmt.**



# Carens (UN)

2006-2013

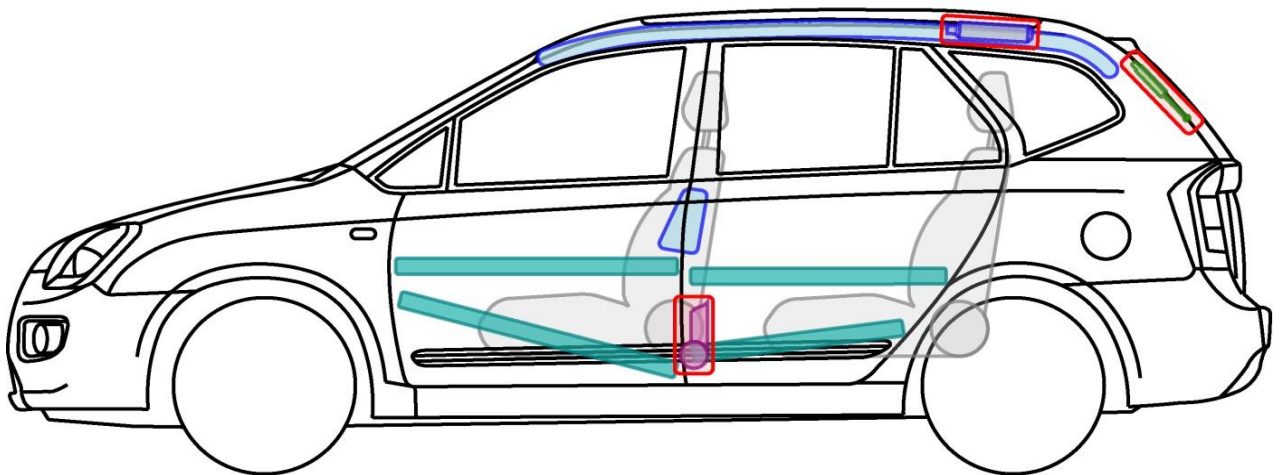
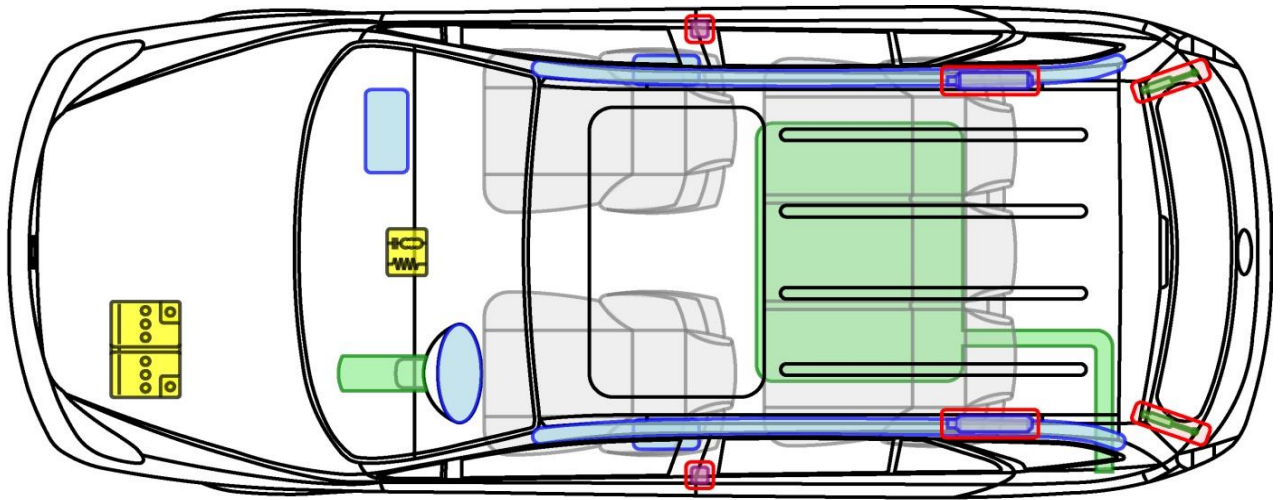

## Legende

	Airbag		Karosserie-verstärkung		Steuergerät
	Gas-generator		Überroll-schutz		Batterie
	Gurt-straffer		Gasdruck-dämpfer		Kraftstoff-tank

Carens



# Carens (RP)

ab 2013

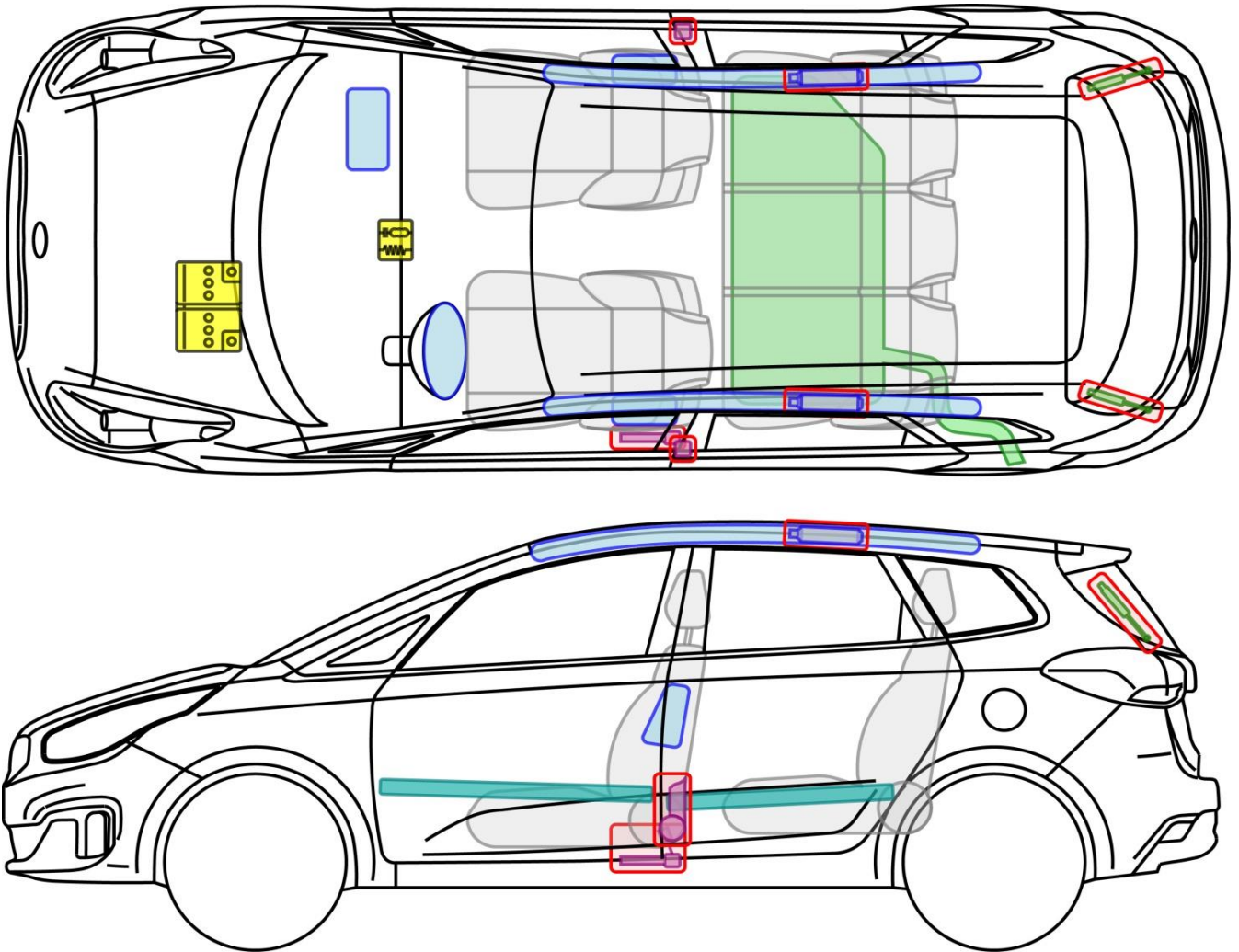

## Legende

	Airbag		Karosserie-verstärkung		Steuergerät
	Gas-generator		Überroll-schutz		Batterie
	Gurt-straffer		Gasdruck-dämpfer		Kraftstoff-tank

Carens



# Carnival (GQ)

1999-2006

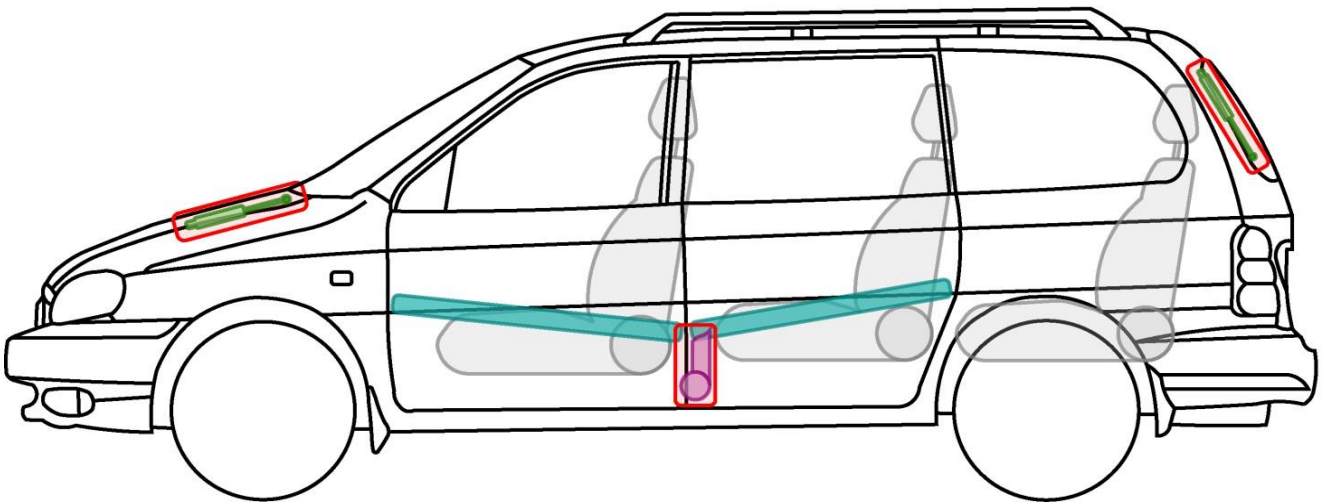
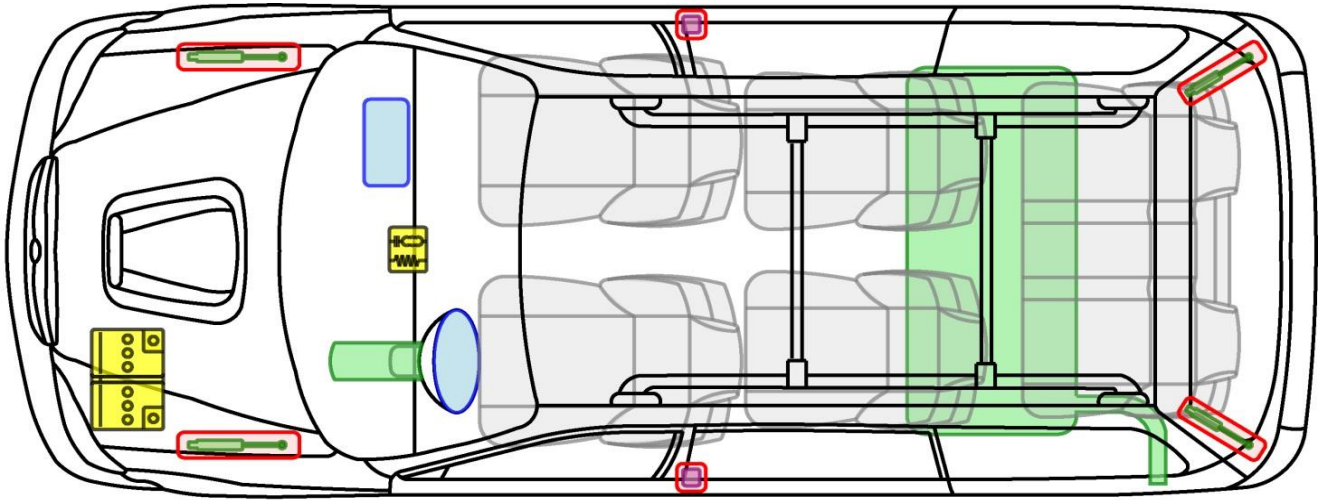

## Legende

	Airbag		Karosserie-verstärkung		Steuergerät
	Gas-generator		Überroll-schutz		Batterie
	Gurt-straffer		Gasdruck-dämpfer		Kraftstoff-tank

Carnival



# Carnival (VQ)

ab 2006

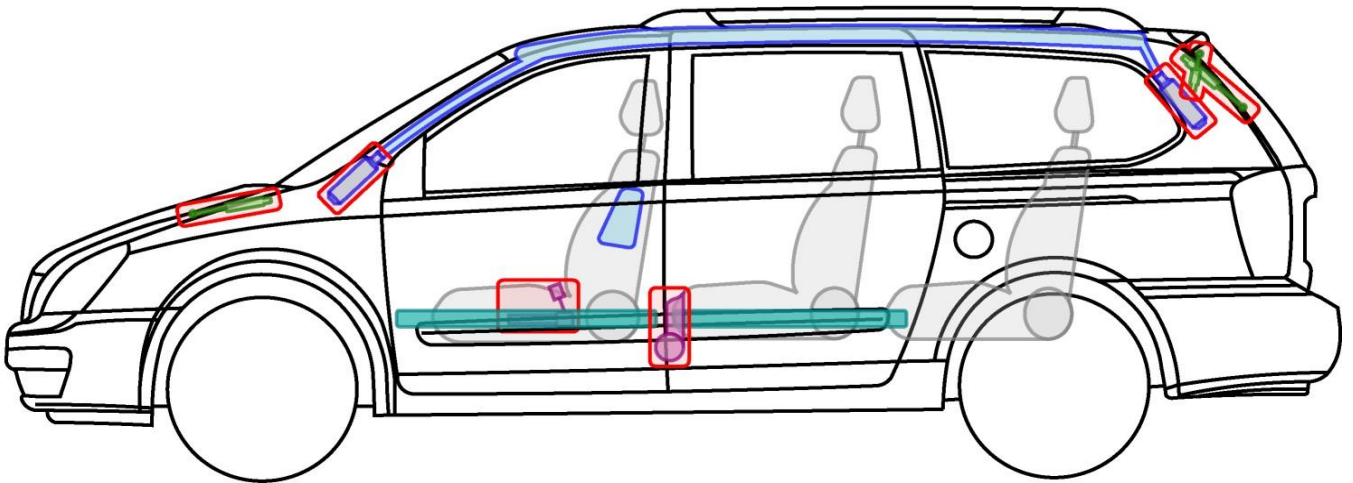
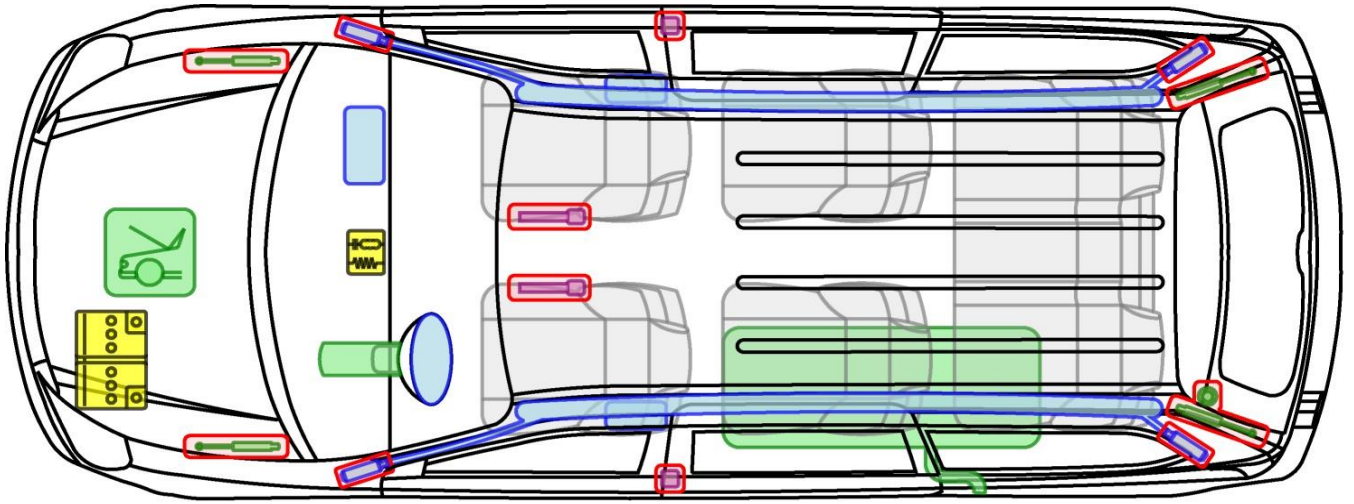

## Legende

	Airbag		Karosserie-verstärkung		Steuergerät
	Gas-generator		Überroll-schutz		Batterie
	Gurt-straffer		Gasdruck-dämpfer		Kraftstoff-tank

Carnival



# cee'd (ED)

5-Türer, 2007-2012

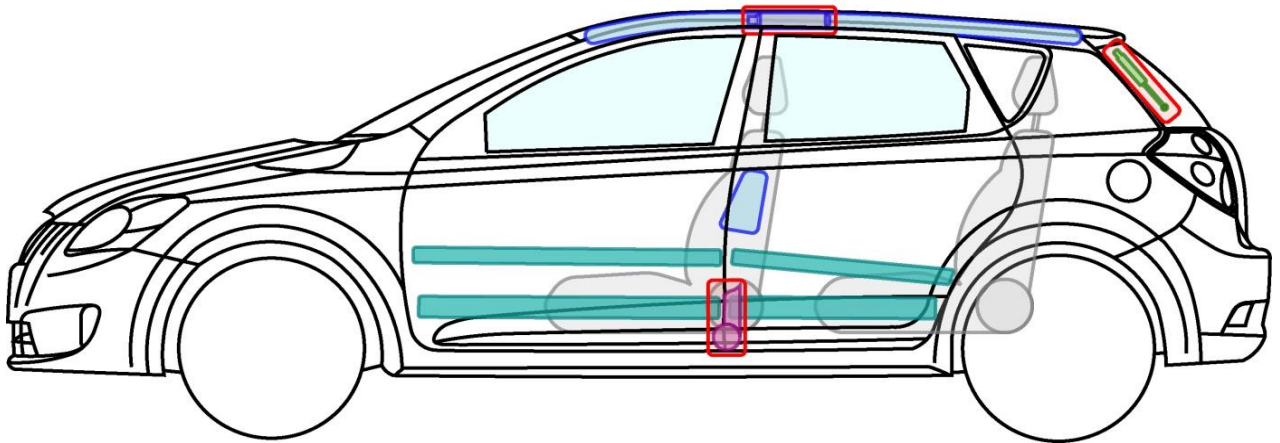
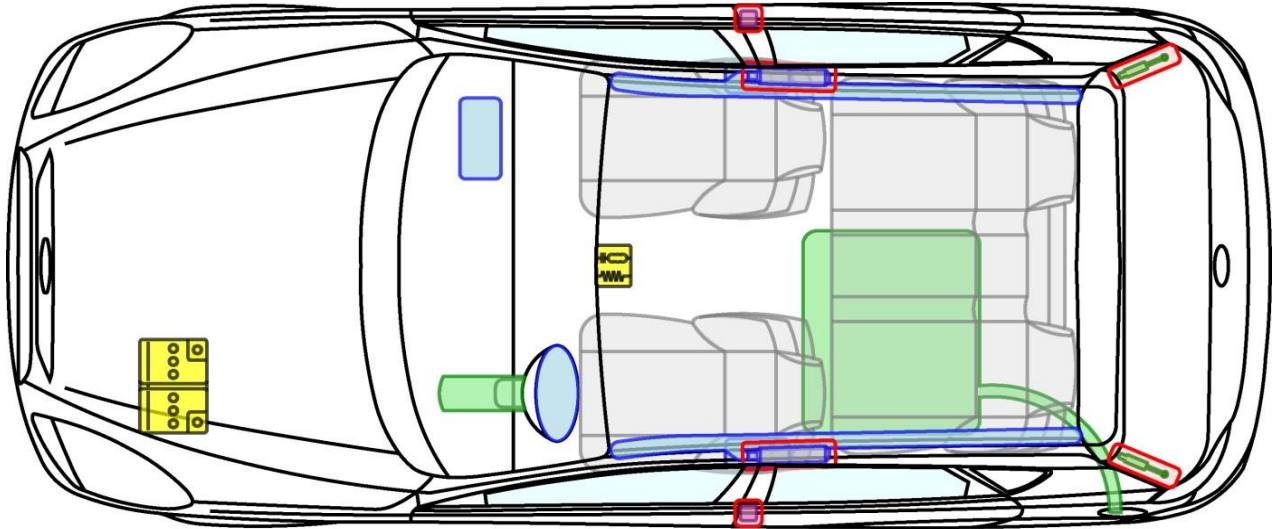

## Legende

	Airbag		Karosserie-verstärkung		Steuergerät
	Gas-generator		Überroll-schutz		Batterie
	Gurt-traffer		Gasdruck-dämpfer		Kraftstoff-tank





# cee'd\_sw (ED)

Sporty Wagon, 2007-2012

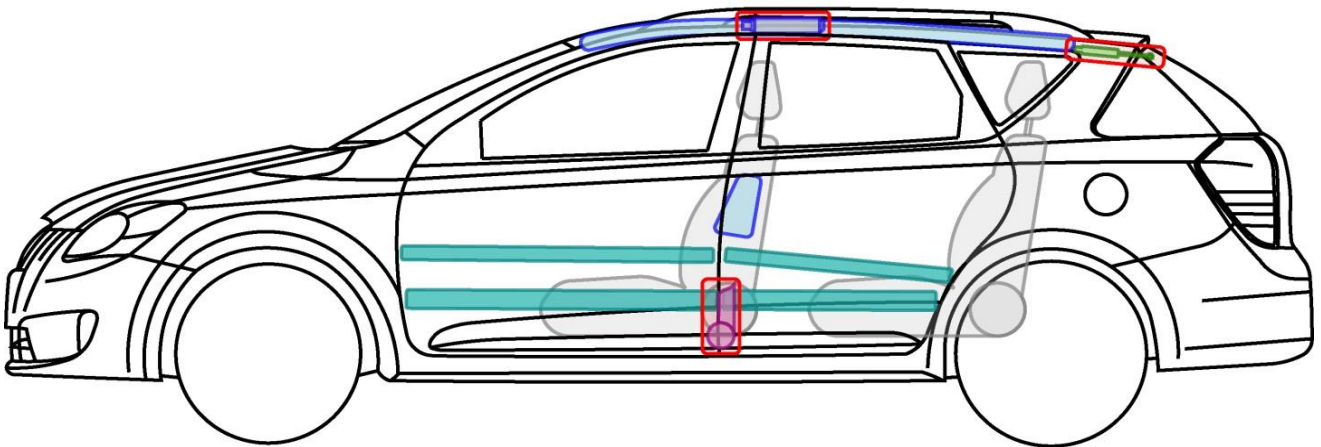
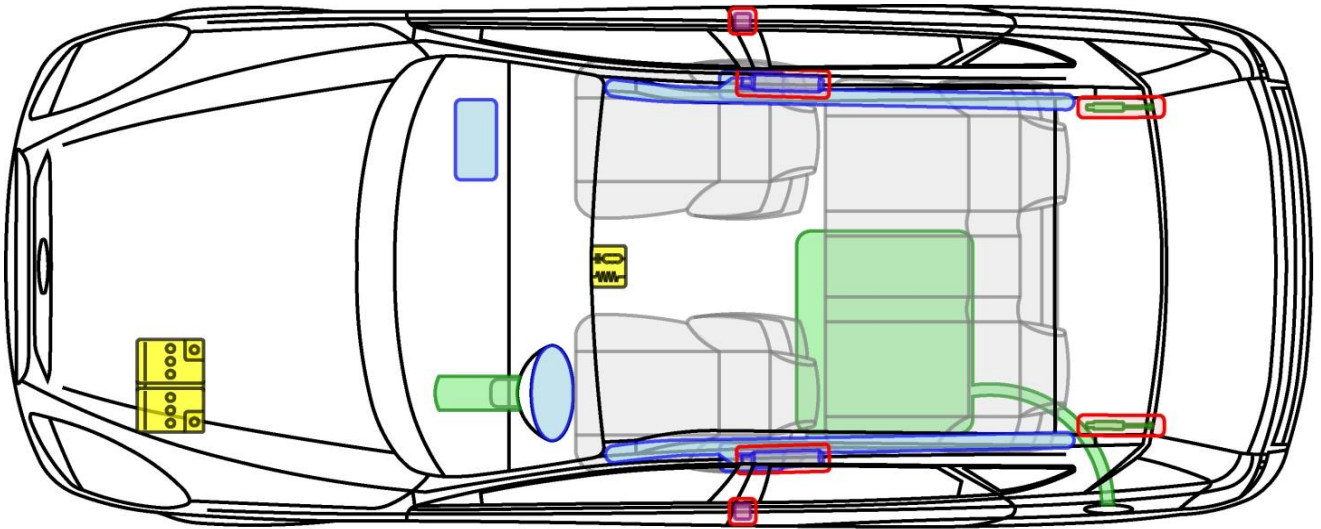

## Legende

	Airbag		Karosserie-verstärkung		Steuergerät
	Gas-generator		Überroll-schutz		Batterie
	Gurt-straffer		Gasdruck-dämpfer		Kraftstoff-tank

cee'd\_sw



# pro\_cee'd (ED)

3-Türer, 2008-2012

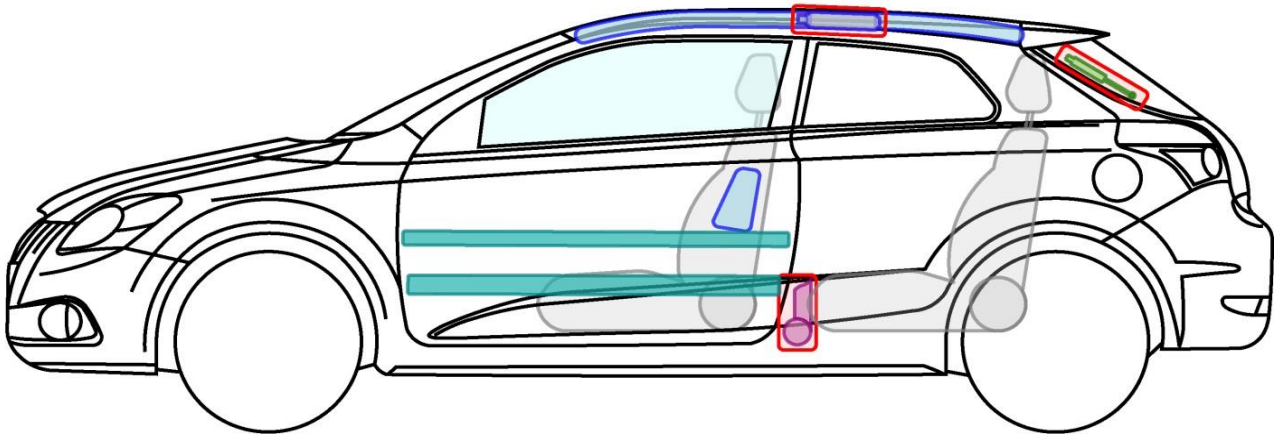
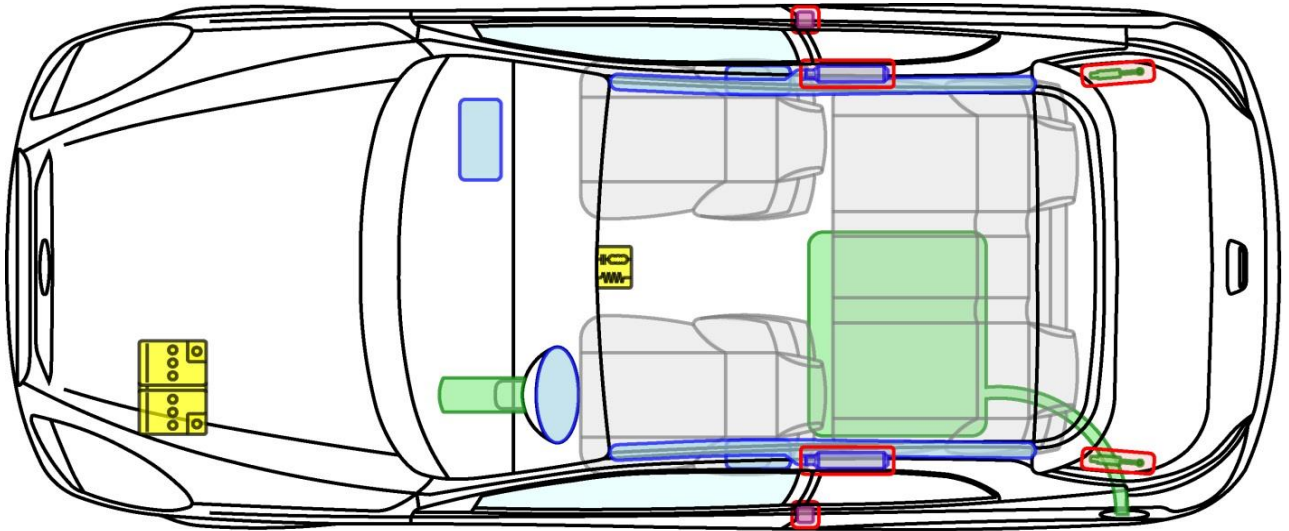

## Legende

	Airbag		Karosserie-verstärkung		Steuergerät
	Gas-generator		Überroll-schutz		Batterie
	Gurt-straffer		Gasdruck-dämpfer		Kraftstoff-tank

pro\_cee'd









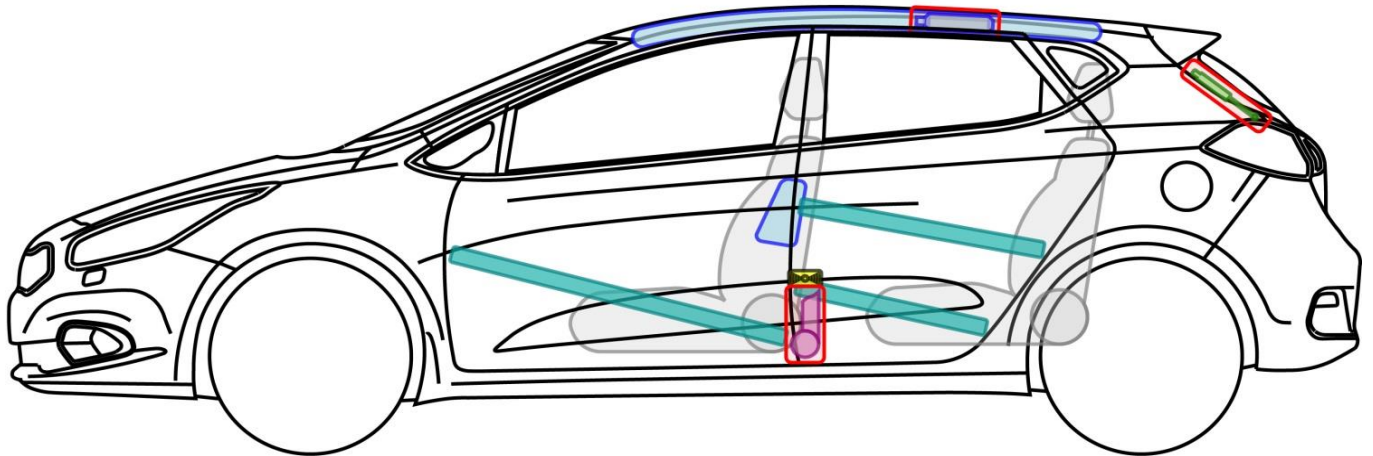
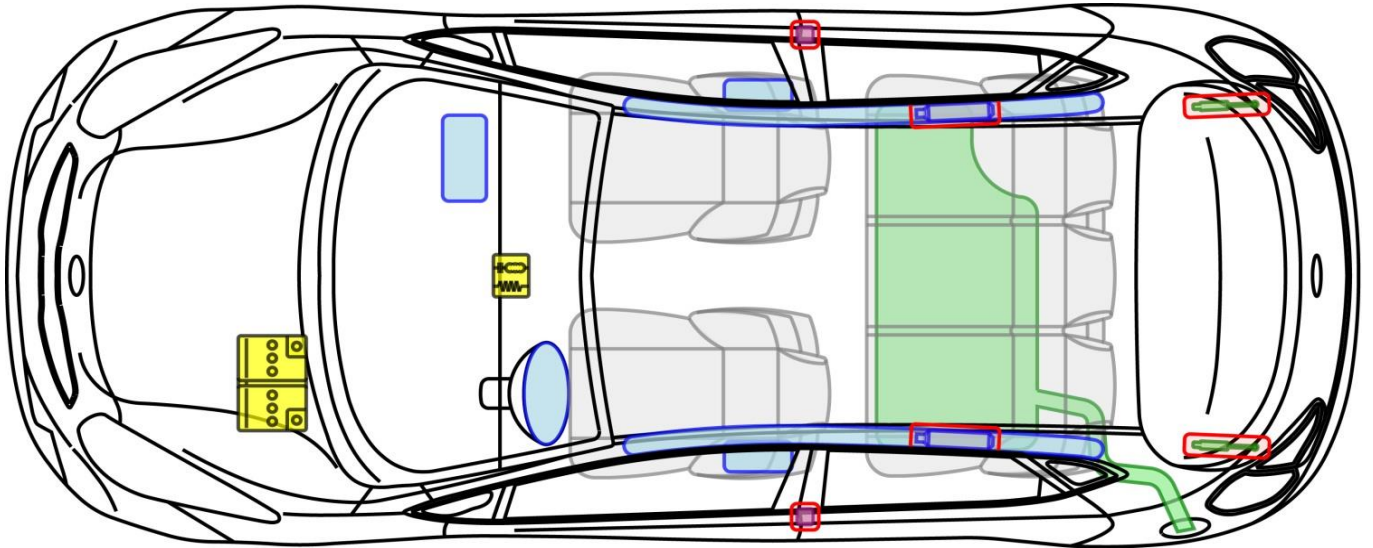

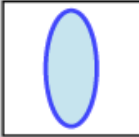

# cee'd (JD)

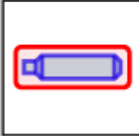
5-Türer, ab 2012  
inklusive Facelift



## Legende

	Airbag		Karosserie- verstärkung		Steuergerät
	Gas- generator		Überroll- schutz		Batterie
	Gurt- straffer		Gasdruck- dämpfer		Kraftstoff- tank

cee'd



# cee'd\_sw (JD)

Sportswagon, ab 2012  
inklusive Facelift

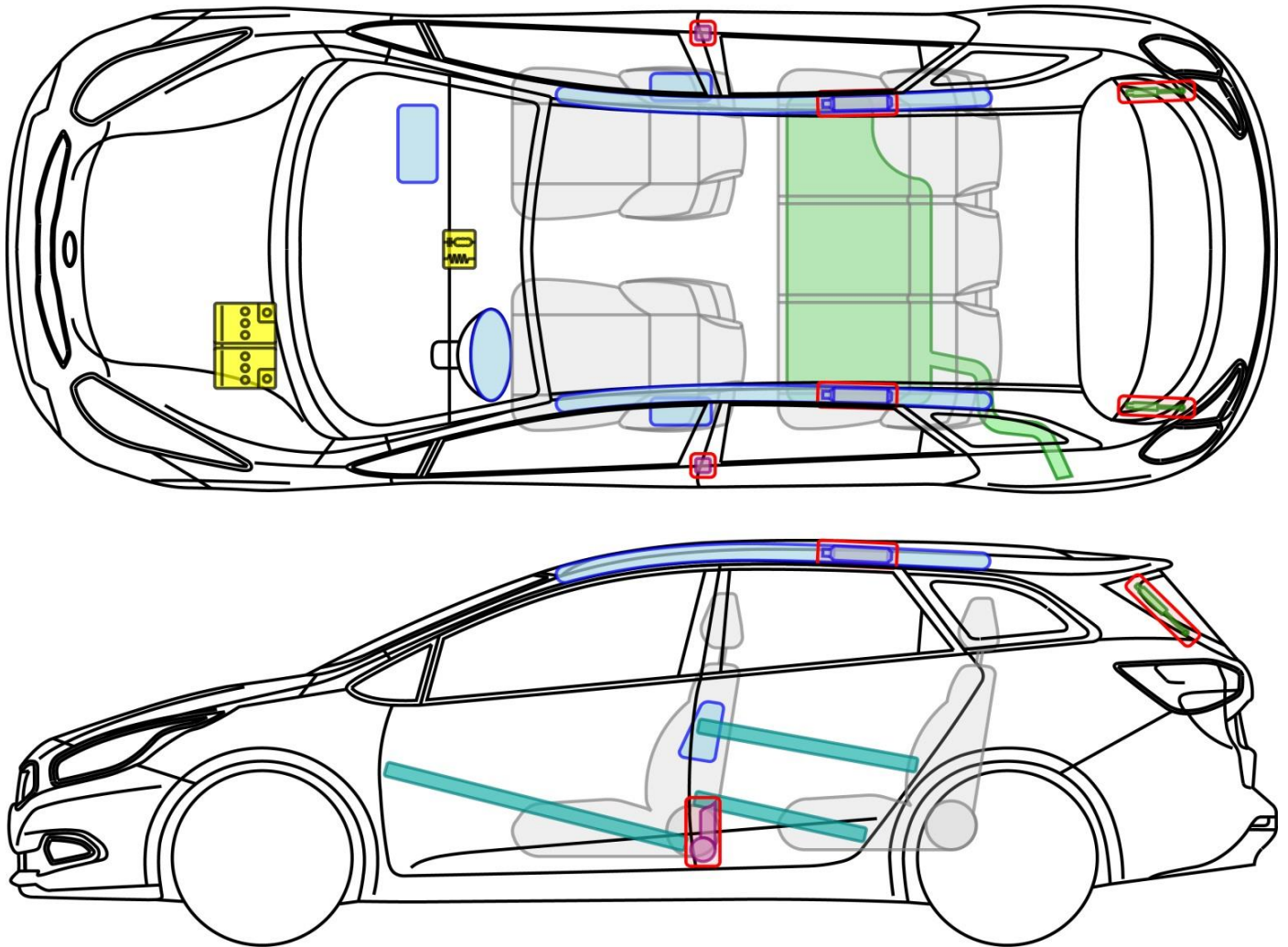

## Legende

	Airbag		Karosserie- verstärkung		Steuergerät
	Gas- generator		Überroll- schutz		Batterie
	Gurt- straffer		Gasdruck- dämpfer		Kraftstoff- tank

cee'd



# pro\_ceed (JD)

3-Türer, ab 2013  
inklusive Facelift

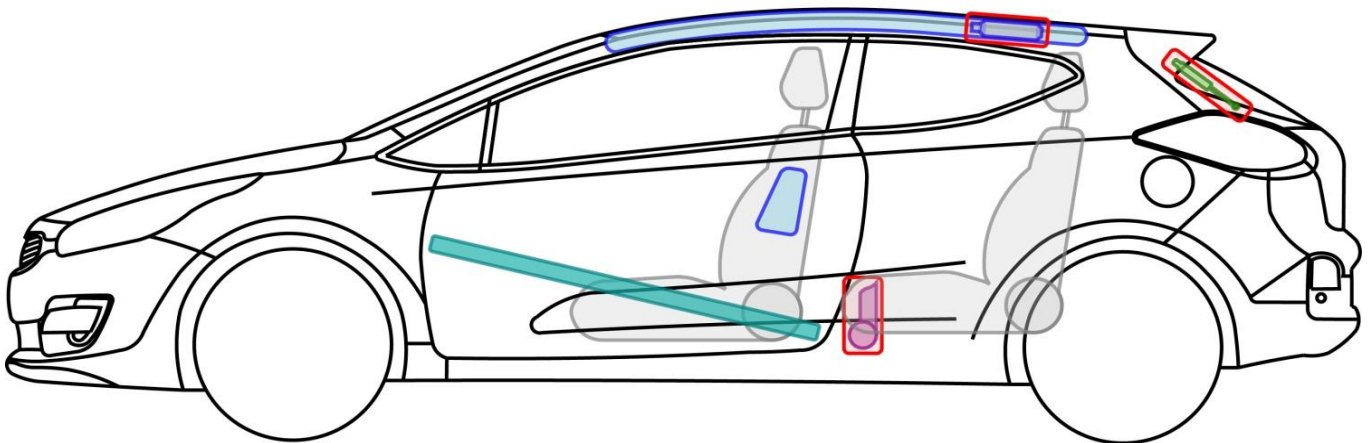
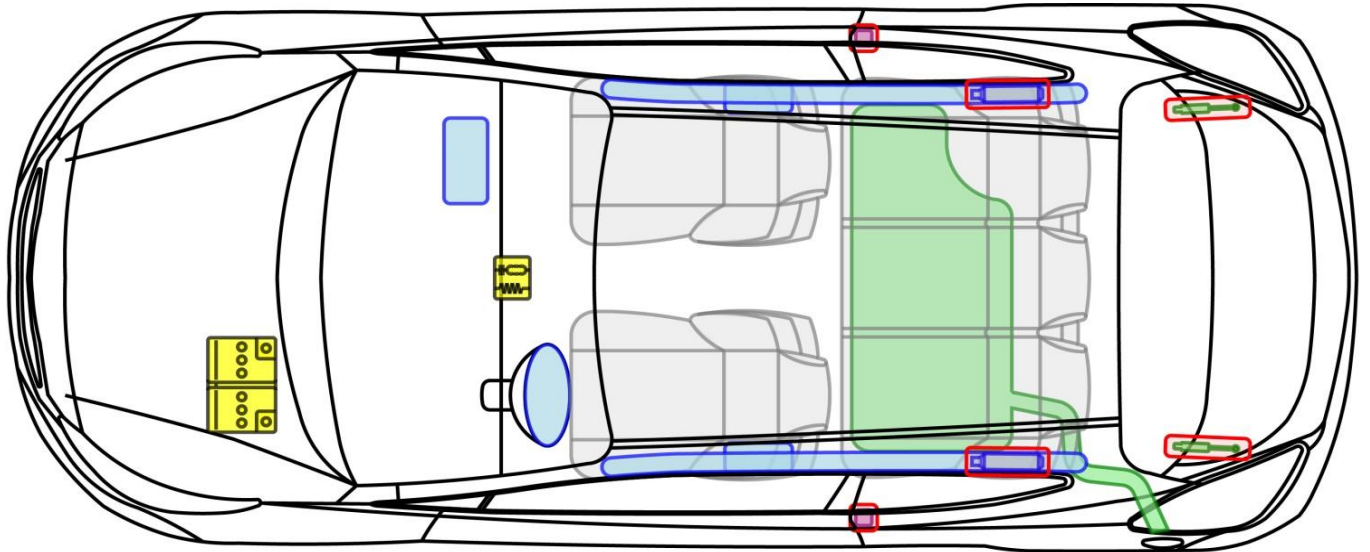

## Legende

	Airbag		Karosserie- verstärkung		Steuergerät
	Gas- generator		Überroll- schutz		Batterie
	Gurt- straffer		Gasdruck- dämpfer		Kraftstoff- tank

ceed





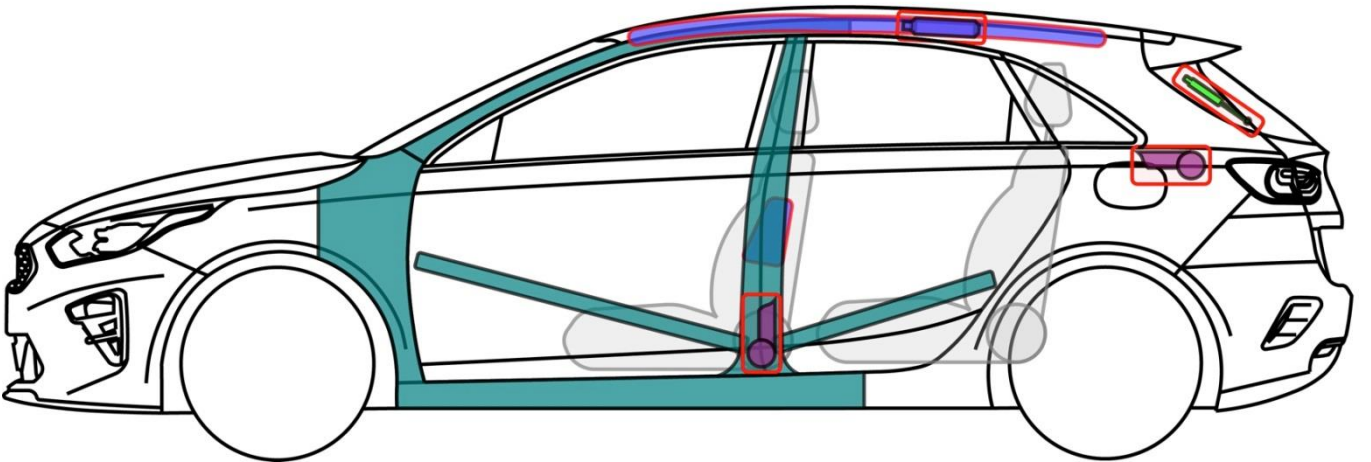
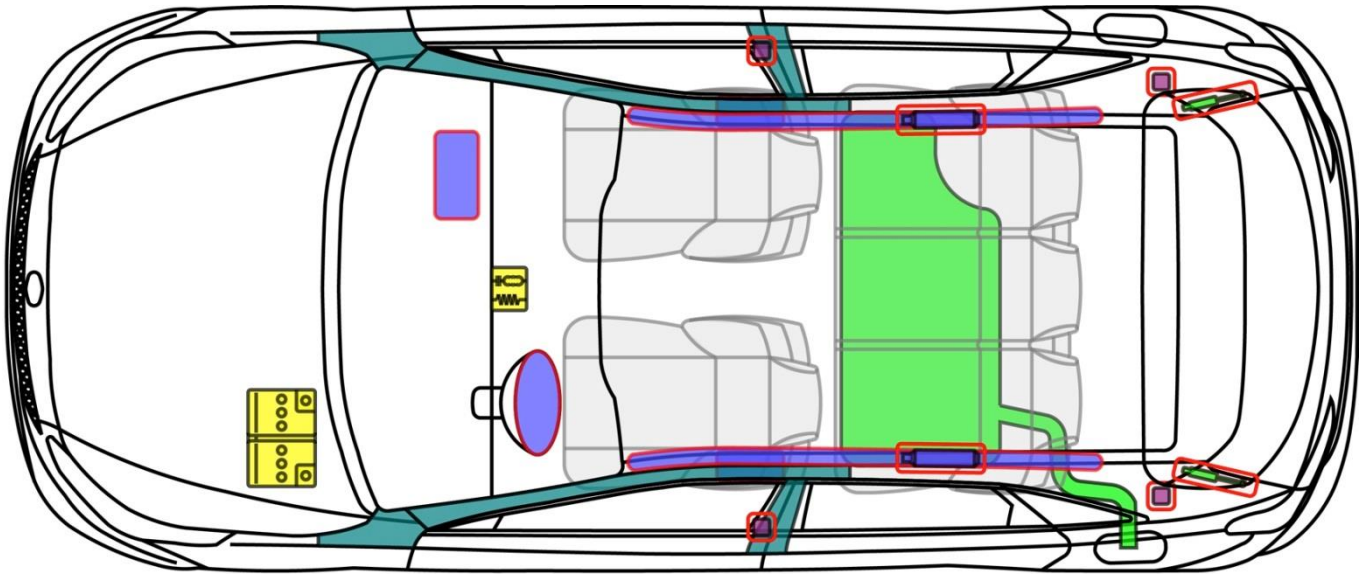

# Ceed (CD)

5-Türer ab 2018

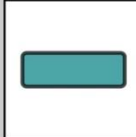

## Legende

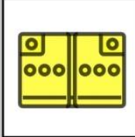
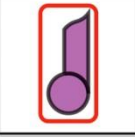
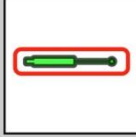
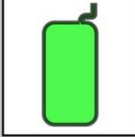
	Airbag		Karosserie- verstärkung		Steuergerät
	Gas- generator		Fußgänger- Schutz- system		12 V Batterie
	Gurt- straffer		Gasdruck- dämpfer		Kraftstoff- tank

Ceed







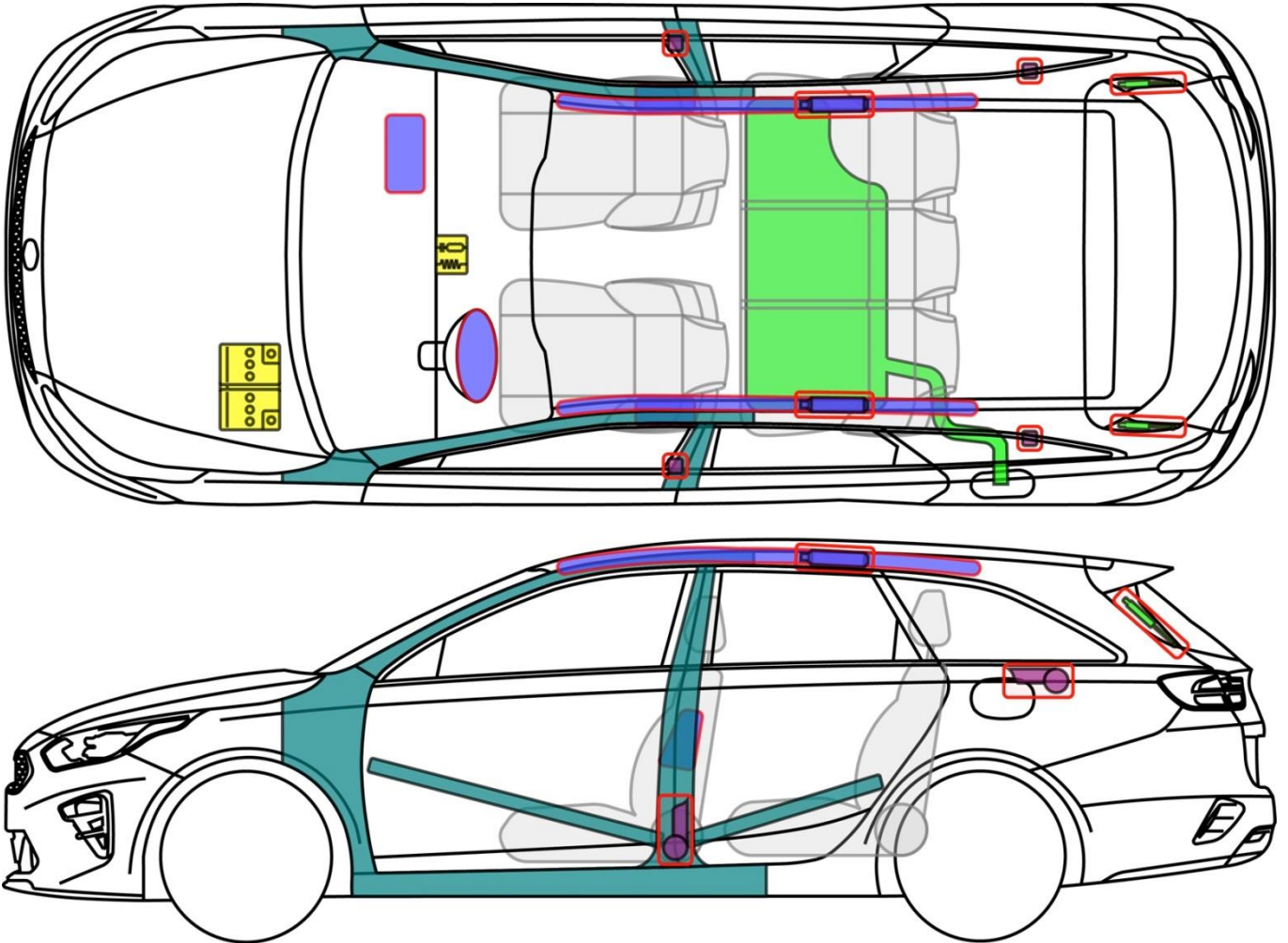

# Ceed sw (CD)

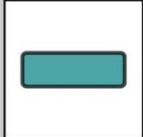
Sportswagon ab 2018

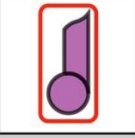

## Legende

	Airbag		Karosserie- verstärkung		Steuergerät
	Gas- generator		Fußgänger- Schutz- system		12 V Batterie
	Gurt- straffer		Gasdruck- dämpfer		Kraftstoff- tank

Ceed sw



# ProCeed (CD)

5-Türer Coupe ab 2019

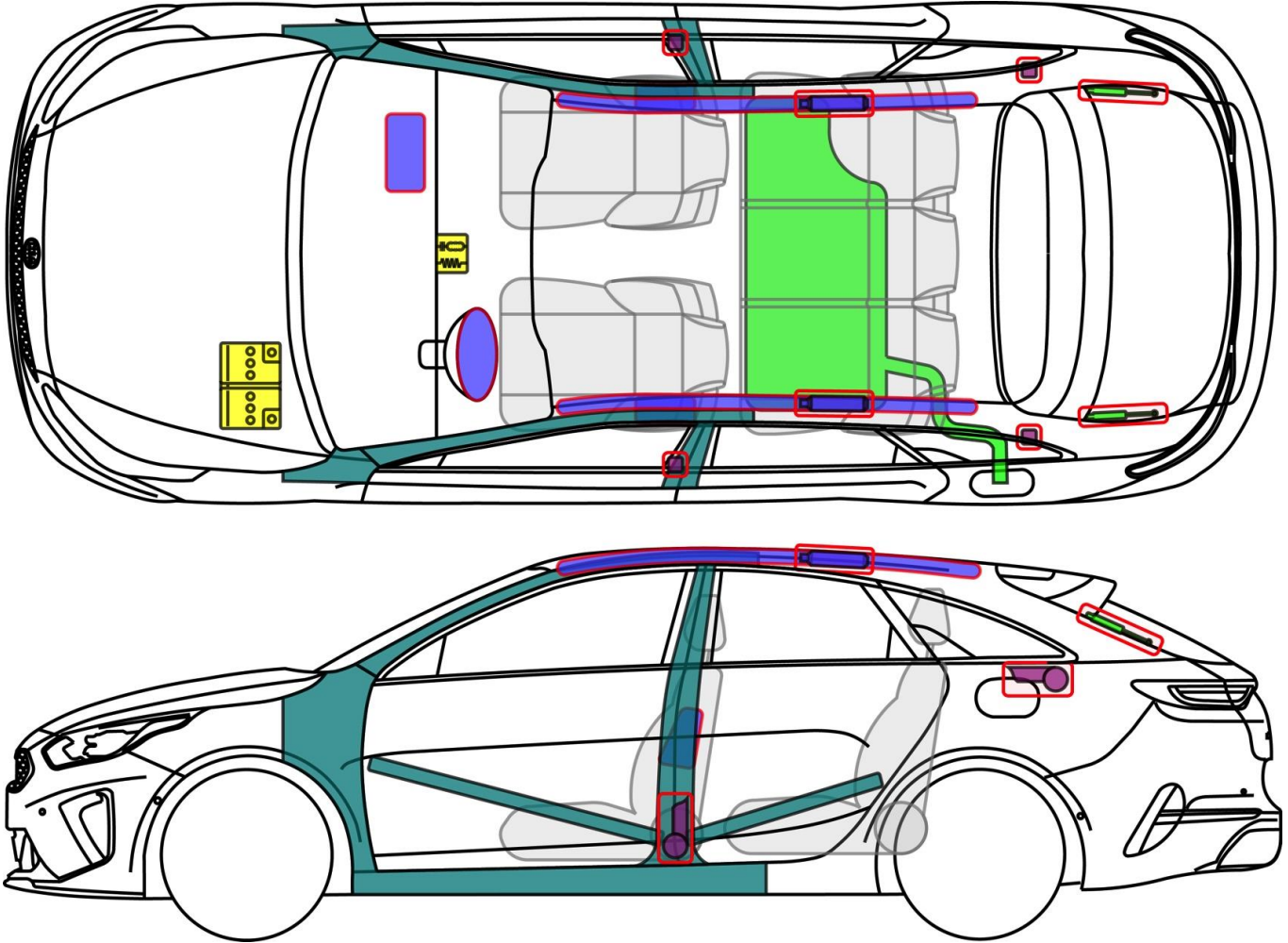

## Legende

	Airbag		Karosserie- verstärkung		Steuergerät
	Gas- generator		Fußgänger- Schutz- system		12 V Batterie
	Gurt- straffer		Gasdruck- dämpfer		Kraftstoff- tank

ProCeed



# Cerato (LD)

Limousine, 2004-2008

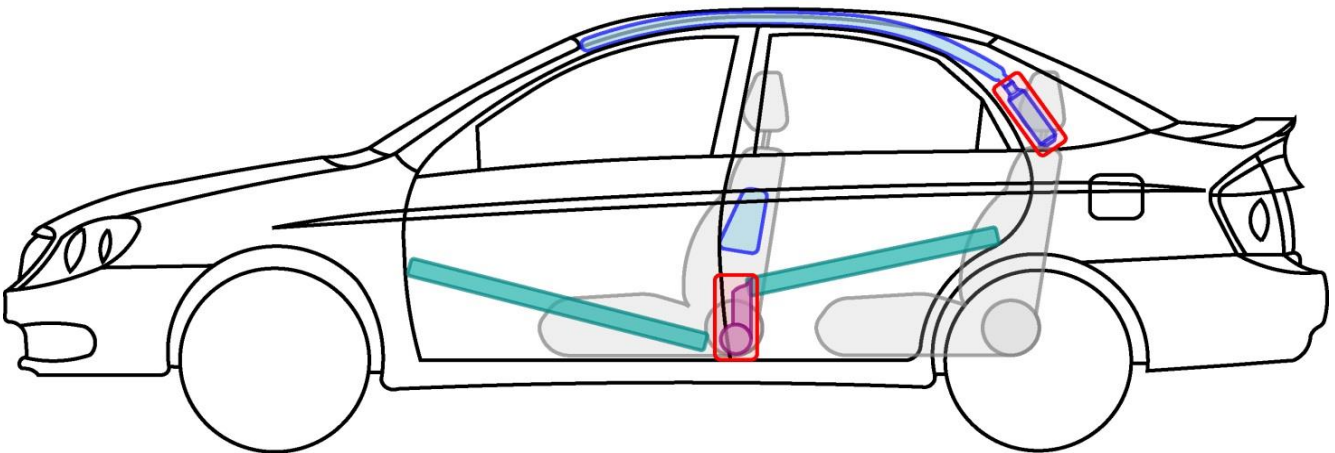
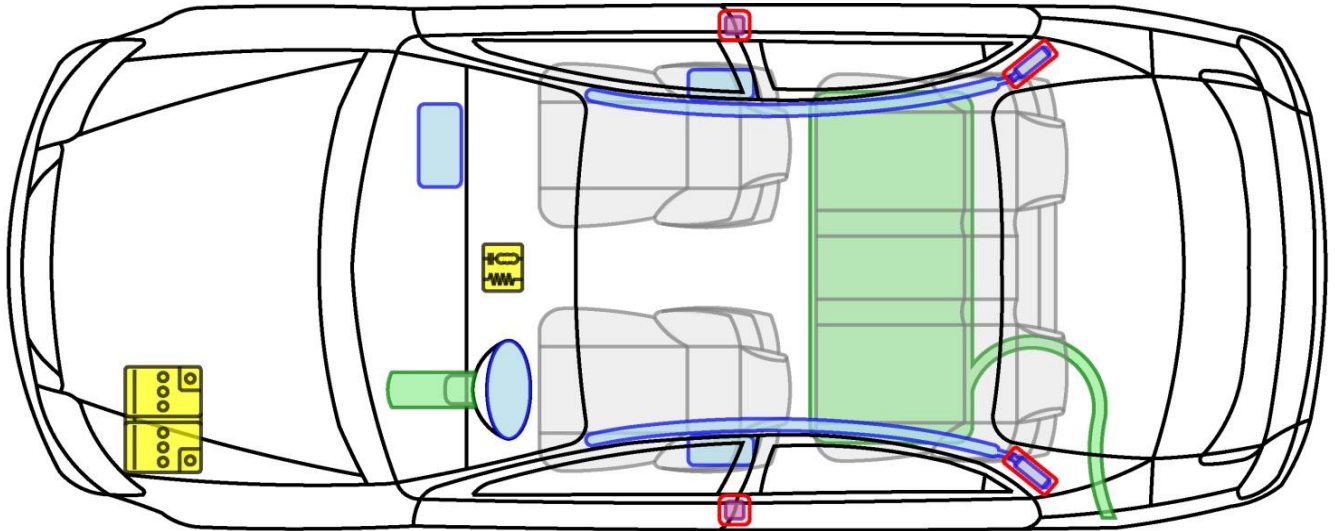

## Legende

	Airbag		Karosserie-verstärkung		Steuergerät
	Gas-generator		Überroll-schutz		Batterie
	Gurt-traffer		Gasdruck-dämpfer		Kraftstoff-tank

Cerato







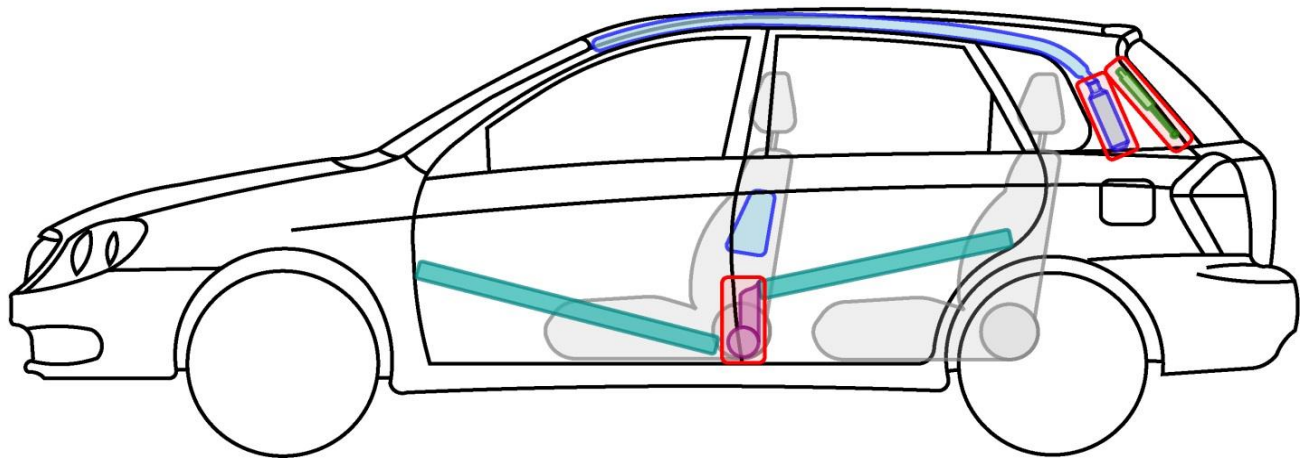
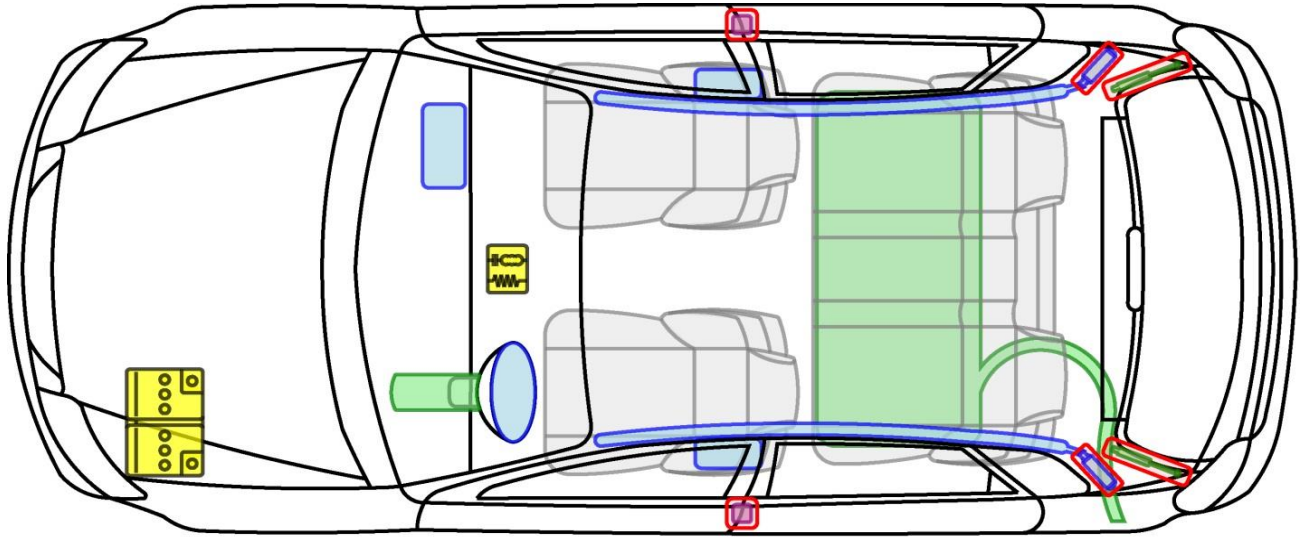

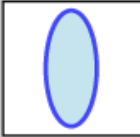

# Cerato (LD)

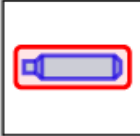
5-Türer, 2004-2007



## Legende

	Airbag		Karosserie-verstärkung		Steuergerät
	Gas-generator		Überroll-schutz		Batterie
	Gurt-traffer		Gasdruck-dämpfer		Kraftstoff-tank









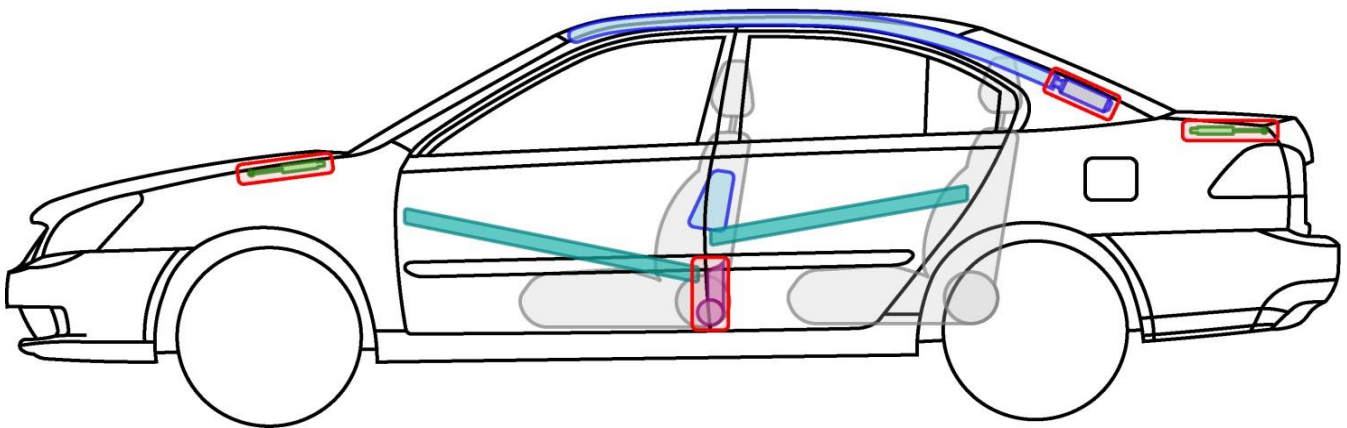
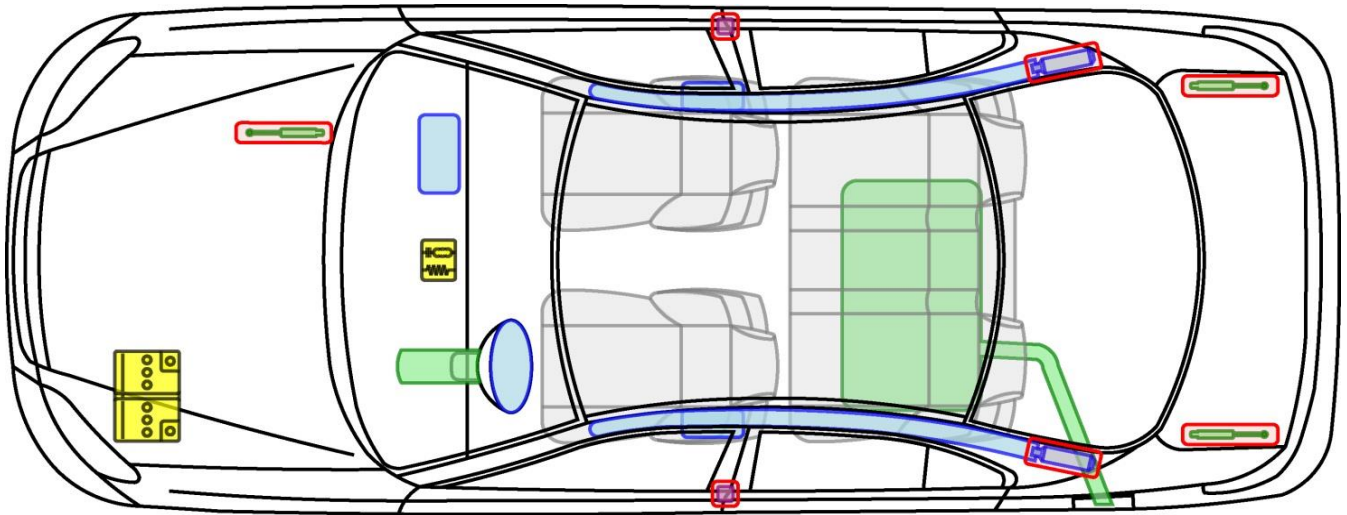



# Magentis (MG)

ab 2006



## Legende

	Airbag		Karosserie- verstärkung		Steuergerät
	Gas- generator		Überroll- schutz		Batterie
	Gurt- straffer		Gasdruck- dämpfer		Kraftstoff- tank

Magentis



# Niro (DE HEV)

ab MY 2016  
12V Batterie

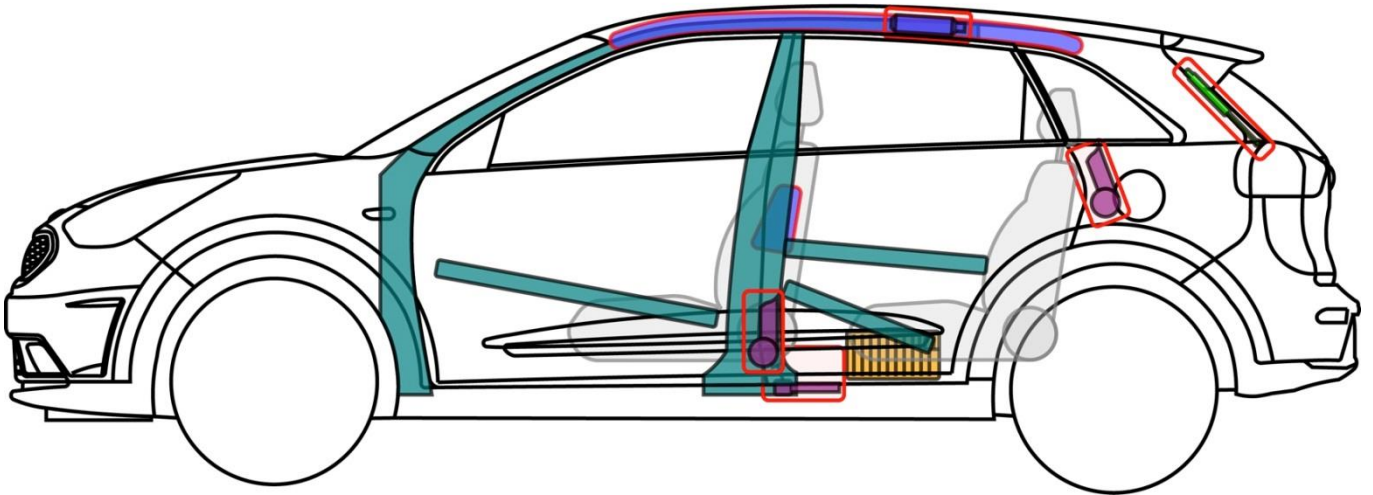
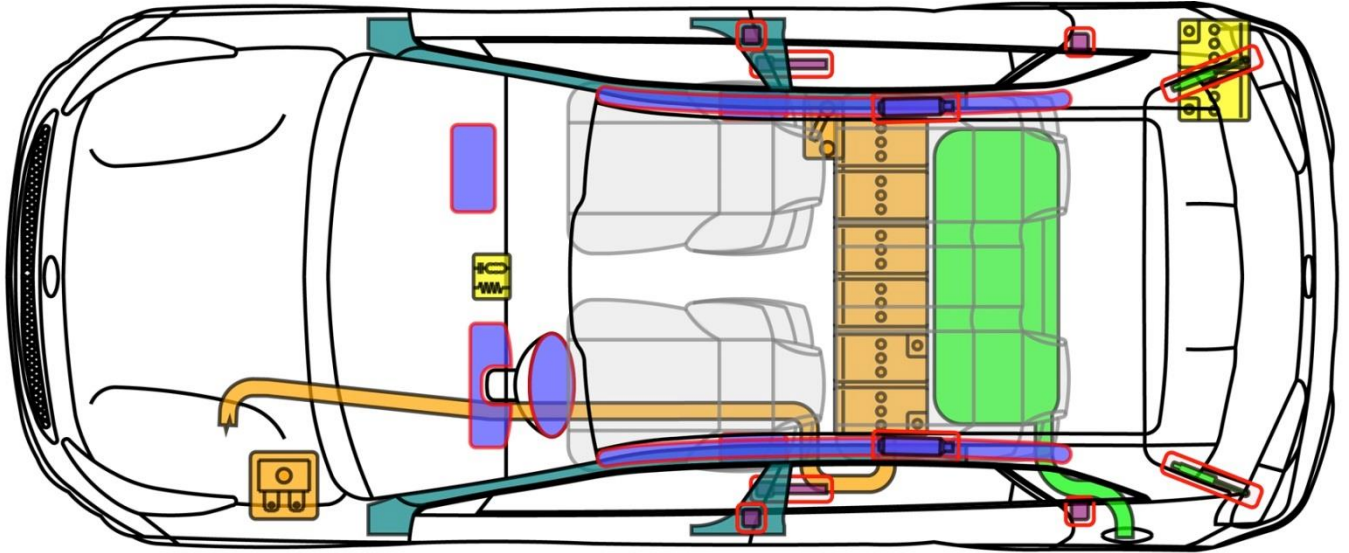

## Legende

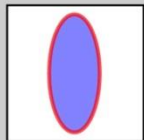

Airbag

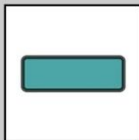

Karosserie-  
verstärkung



Steuergerät

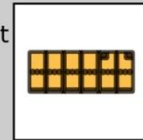

Hochvolt-  
batterie

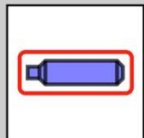

Gas-  
generator



Fußgänger-  
Schutz-  
system

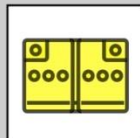

12 V  
Batterie

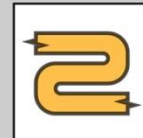

Hochvolt-  
leitung/  
-komponente

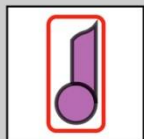

Gurt-  
straffer

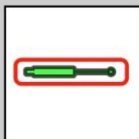

Gasdruck-  
dämpfer

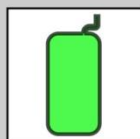

Kraftstoff-  
tank

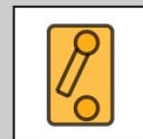

HV-  
Trennstelle

Niro



# Niro (DE HEV)

ab MY 2018-  
12V in HV Batterie

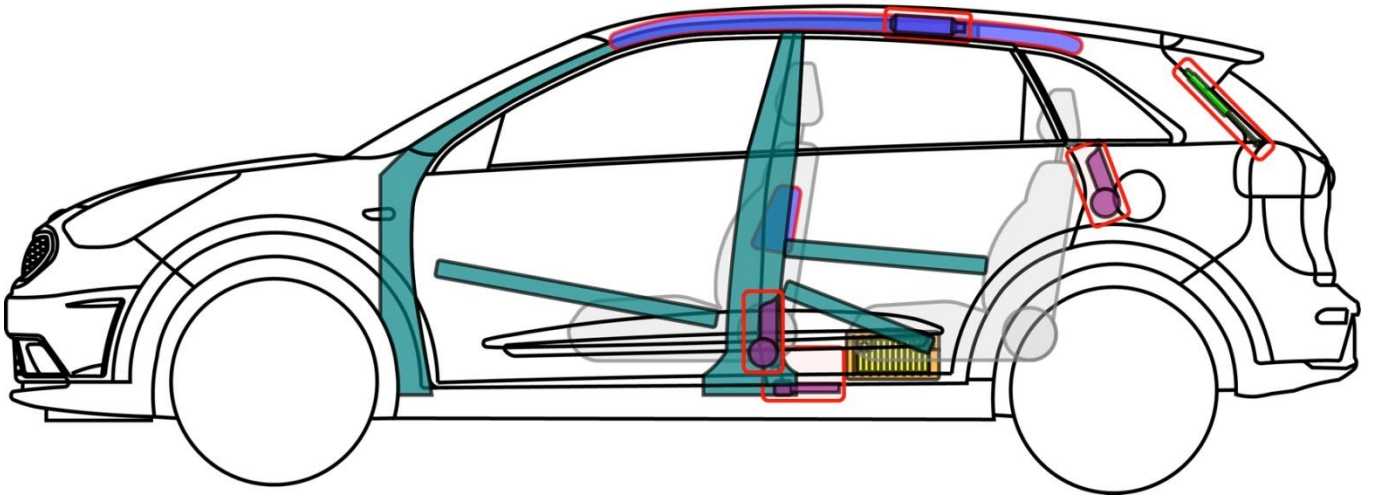
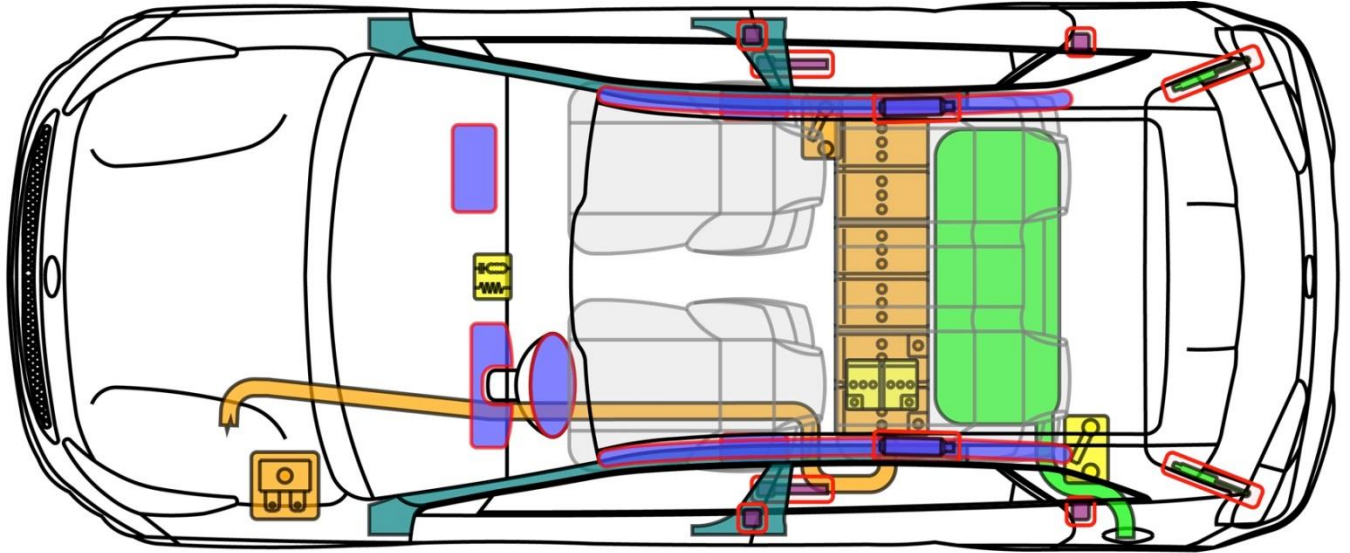

## Legende

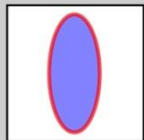

Airbag

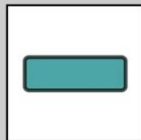

Karosserie-  
verstärkung



Steuergerät

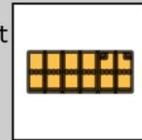

Hochvolt-  
batterie

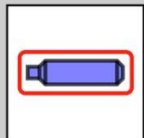

Gas-  
generator

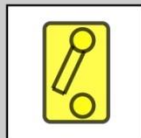

12 V  
Batterie  
Trennstelle

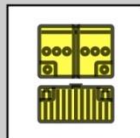

12 V  
Batterie

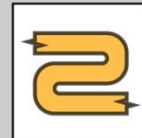

Hochvolt-  
leitung/  
-komponente

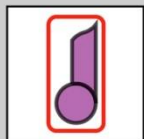

Gurt-  
straffer

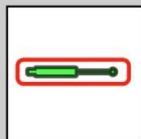

Gasdruck-  
dämpfer

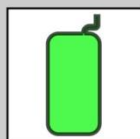

Kraftstoff-  
tank

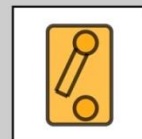

HV-  
Trennstelle

Niro



# Niro (DE PHEV)

Plug-in Hybrid,  
ab 2017 immer 12V Batterie

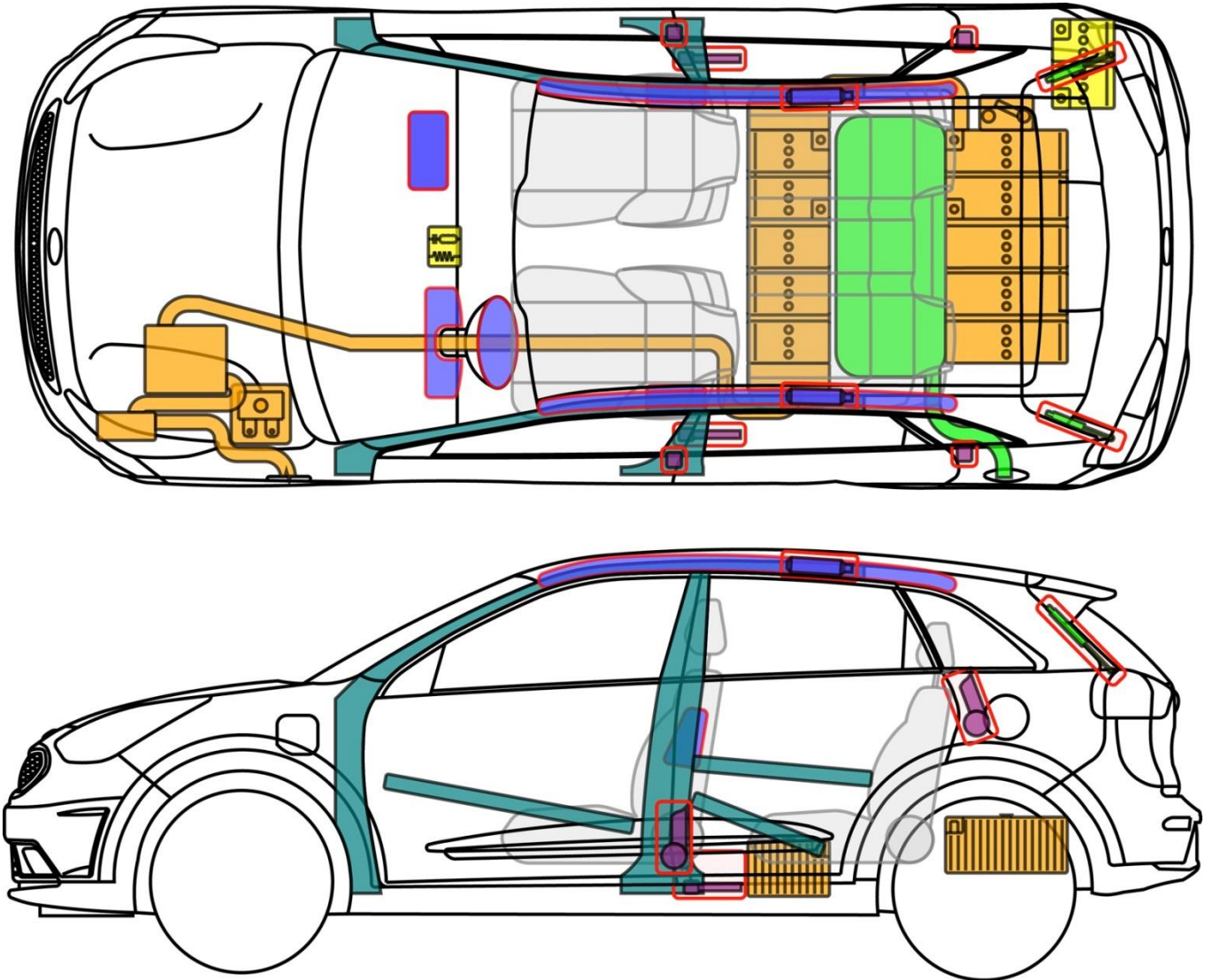

## Legende

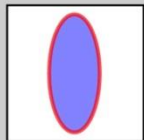

Airbag

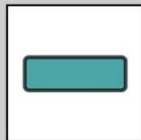

Karosserie-  
verstärkung



Steuergerät

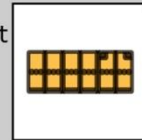

Hochvolt-  
batterie

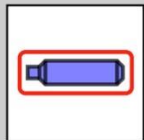

Gas-  
generator



Fußgänger-  
Schutz-  
system

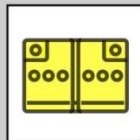

12 V  
Batterie

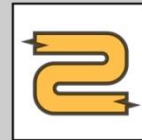

Hochvolt-  
leitung/  
-komponente



Gurt-  
straffer

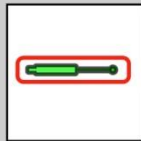

Gasdruck-  
dämpfer

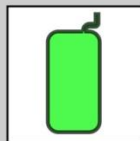

Kraftstoff-  
tank



HV-  
Trennstelle

Niro



# e-Niro (DE EV)

Elektro,  
2018-

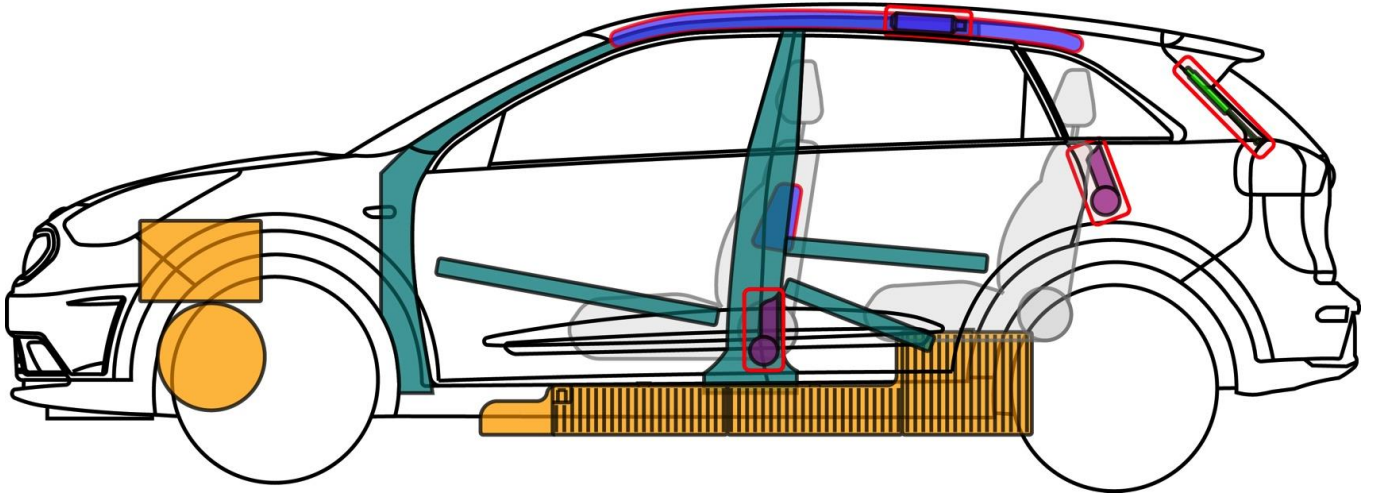
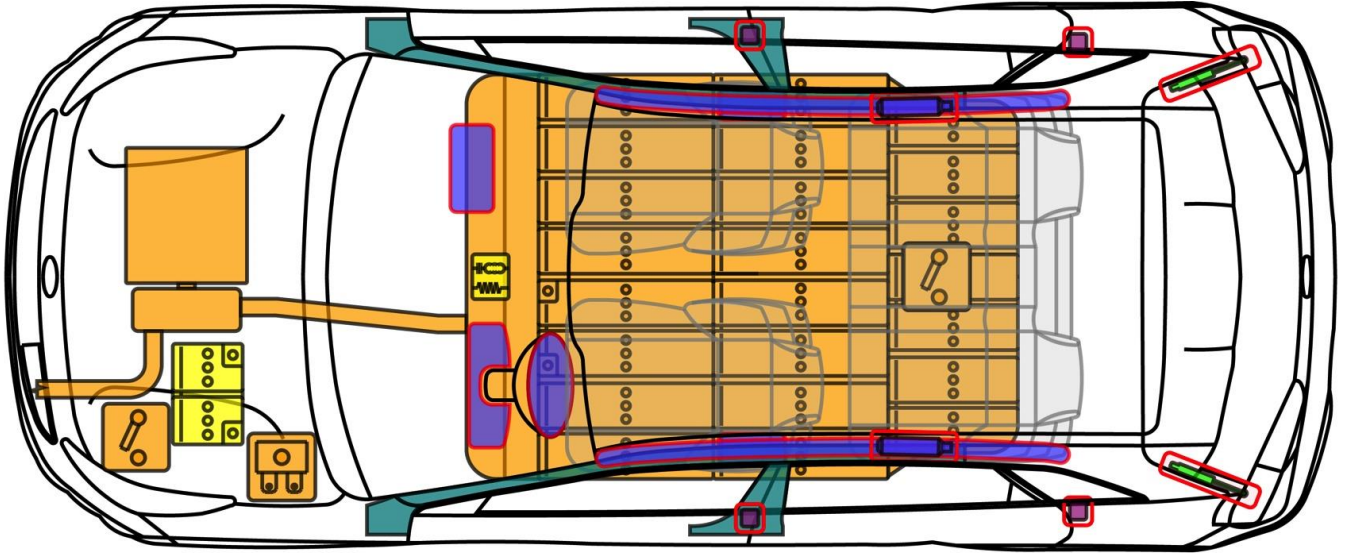

## Legende

	Airbag		Karosserie- verstärkung		Steuergerät		Hochvolt- batterie
	Gas- generator		Fußgänger- Schutz- system		12 V Batterie		Hochvolt- leitung/ -komponente
	Gurt- straffer		Gasdruck- dämpfer		Kraftstoff- tank		HV- Trennstelle

Niro



# Opirus (GH)

ab 2003

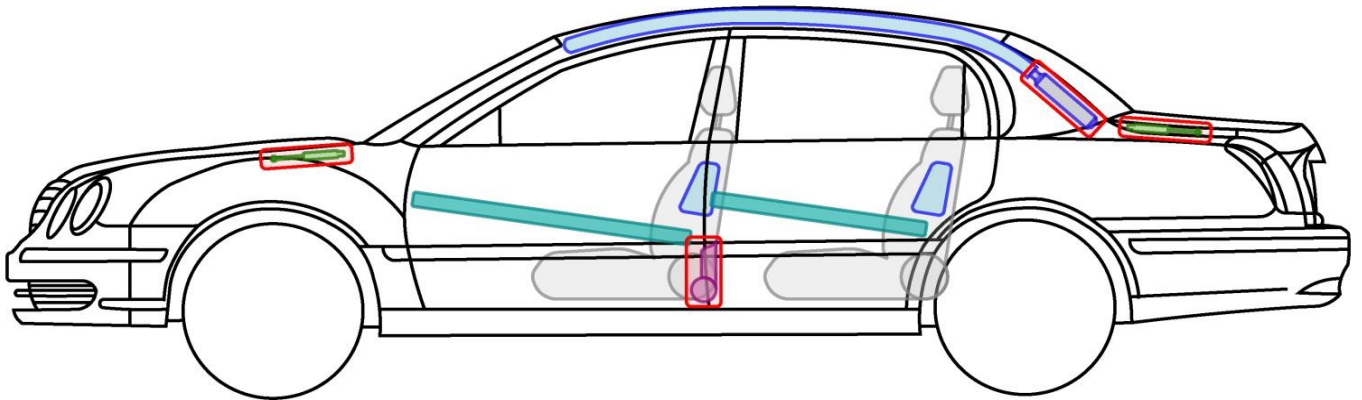
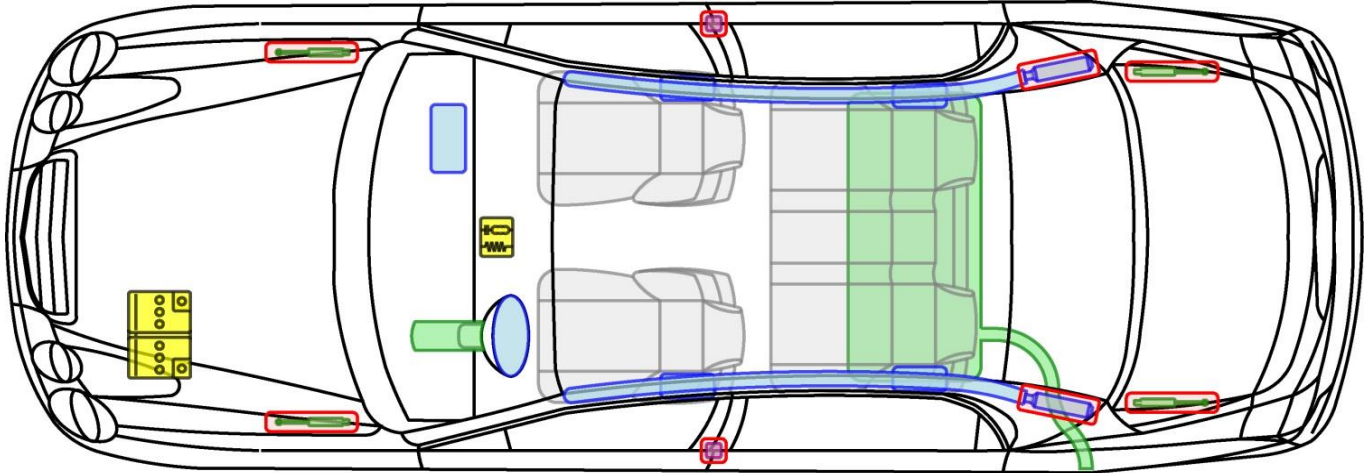

## Legende

	Airbag		Karosserie-verstärkung		Steuergerät
	Gas-generator		Überroll-schutz		Batterie
	Gurt-straffer		Gasdruck-dämpfer		Kraftstoff-tank



# Optima (TF)

2012-2016  
inklusive Facelift

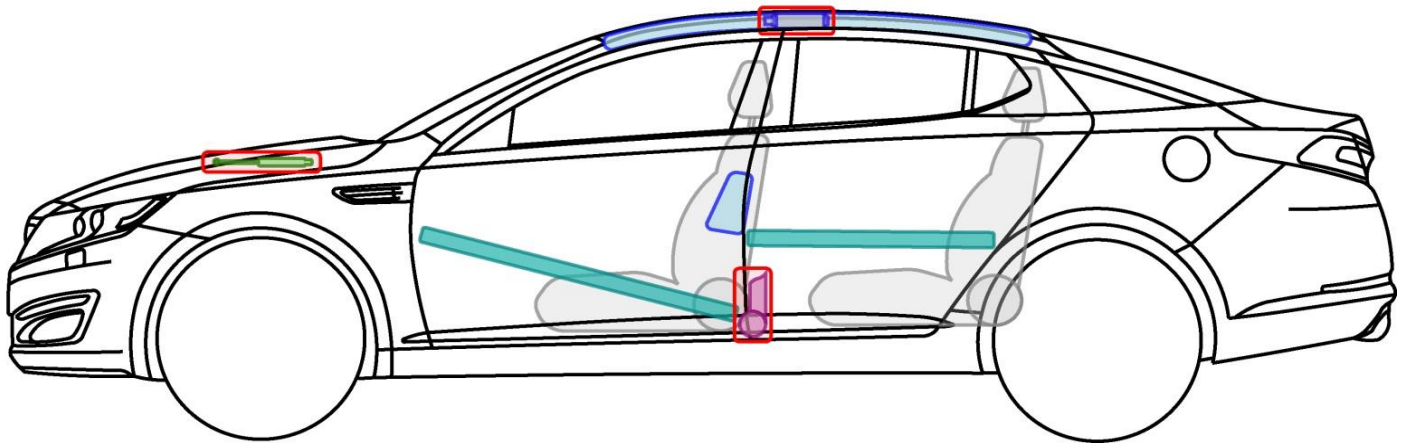
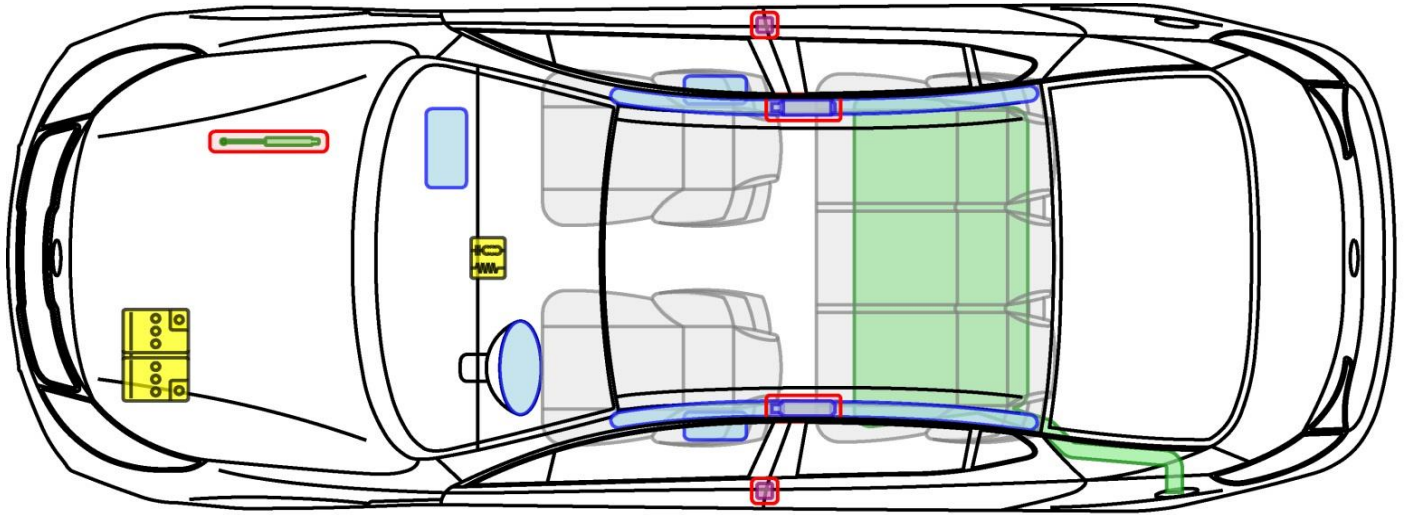

## Legende

	Airbag		Karosserie-verstärkung		Steuergerät
	Gas-generator		Überroll-schutz		Batterie
	Gurt-straffer		Gasdruck-dämpfer		Kraftstoff-tank

Optima



# Optima (TF)

Hybrid, 2012-2016  
inklusive Facelift

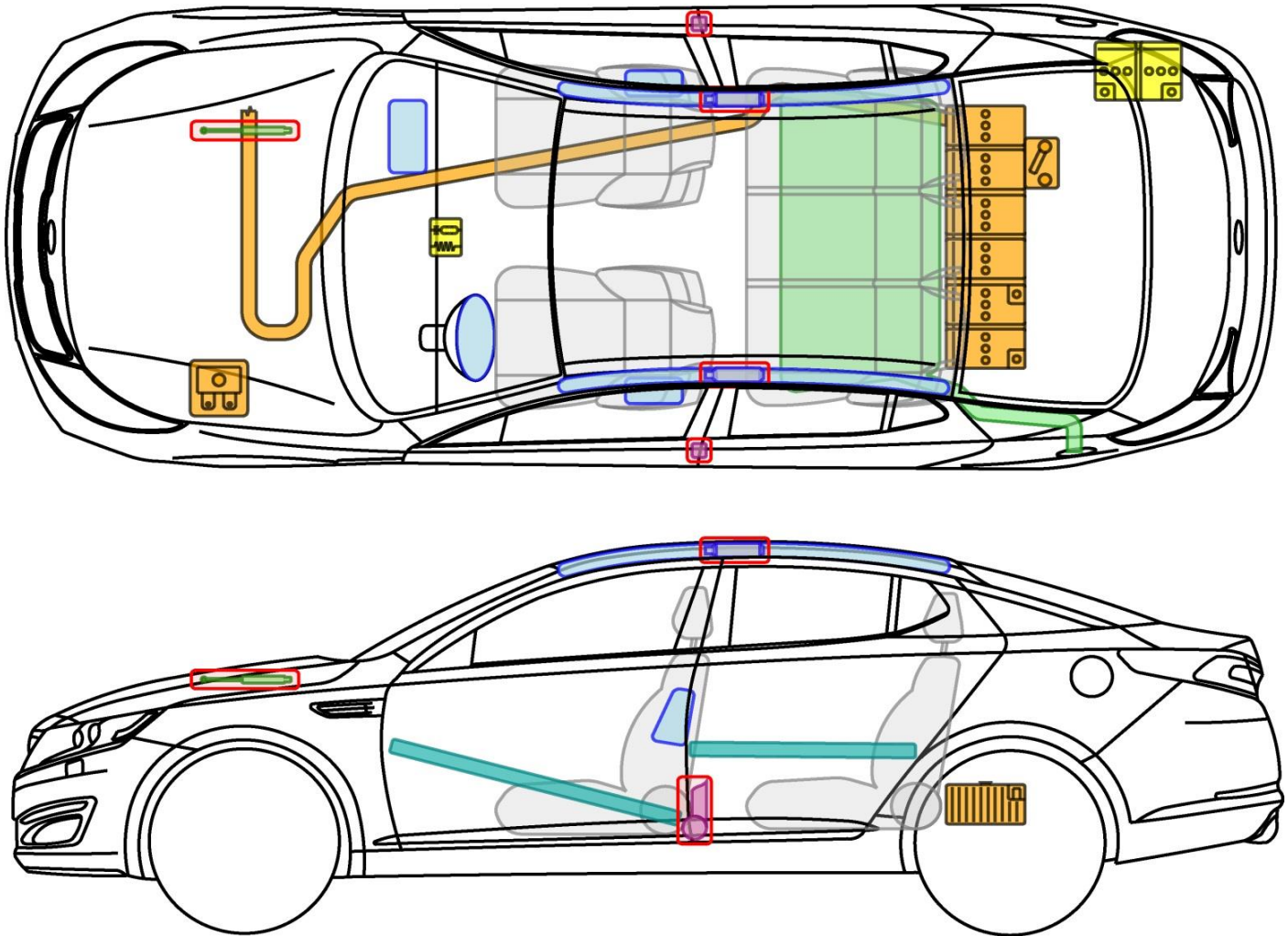

## Legende

	Airbag		Karosserie- verstärkung		Steuergerät		Hochvolt- batterie
	Gas- generator		Überroll- schutz		12 V Batterie		Hochvolt -leitung/ -komponente
	Gurt- straffer		Gasdruck- dämpfer		Kraftstoff- tank		HV- Trennstelle

Optima





# Optima (JF)

4-Türer ab 2016

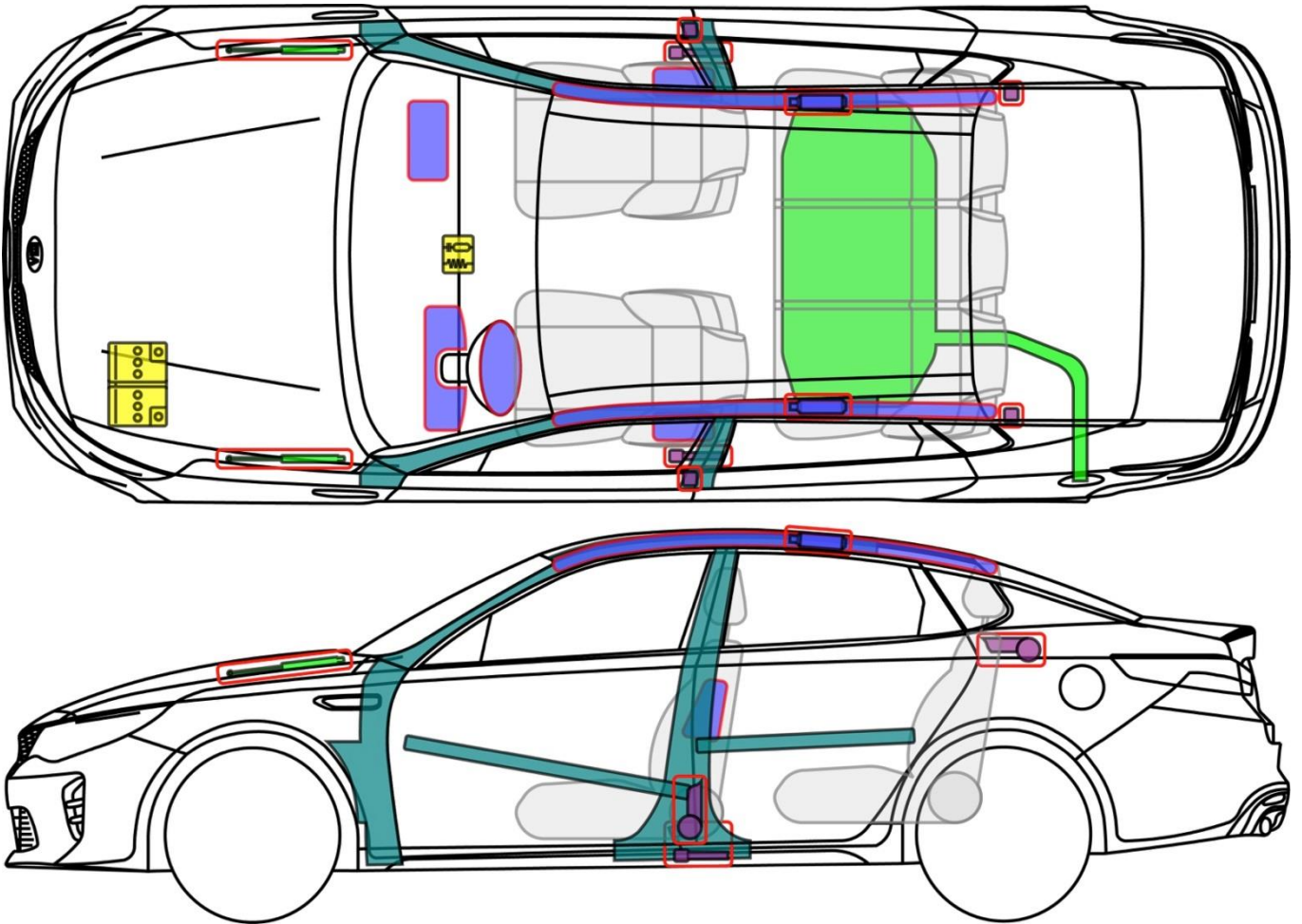

## Legende

	Airbag		Karosserie-verstärkung		Steuergerät
	Gas-generator		Fußgänger-Schutz-system		12 V Batterie
	Gurt-straffer		Gasdruck-dämpfer		Kraftstoff-tank

Optima



# Optima (JF)

Plug-in Hybrid,  
ab 2016

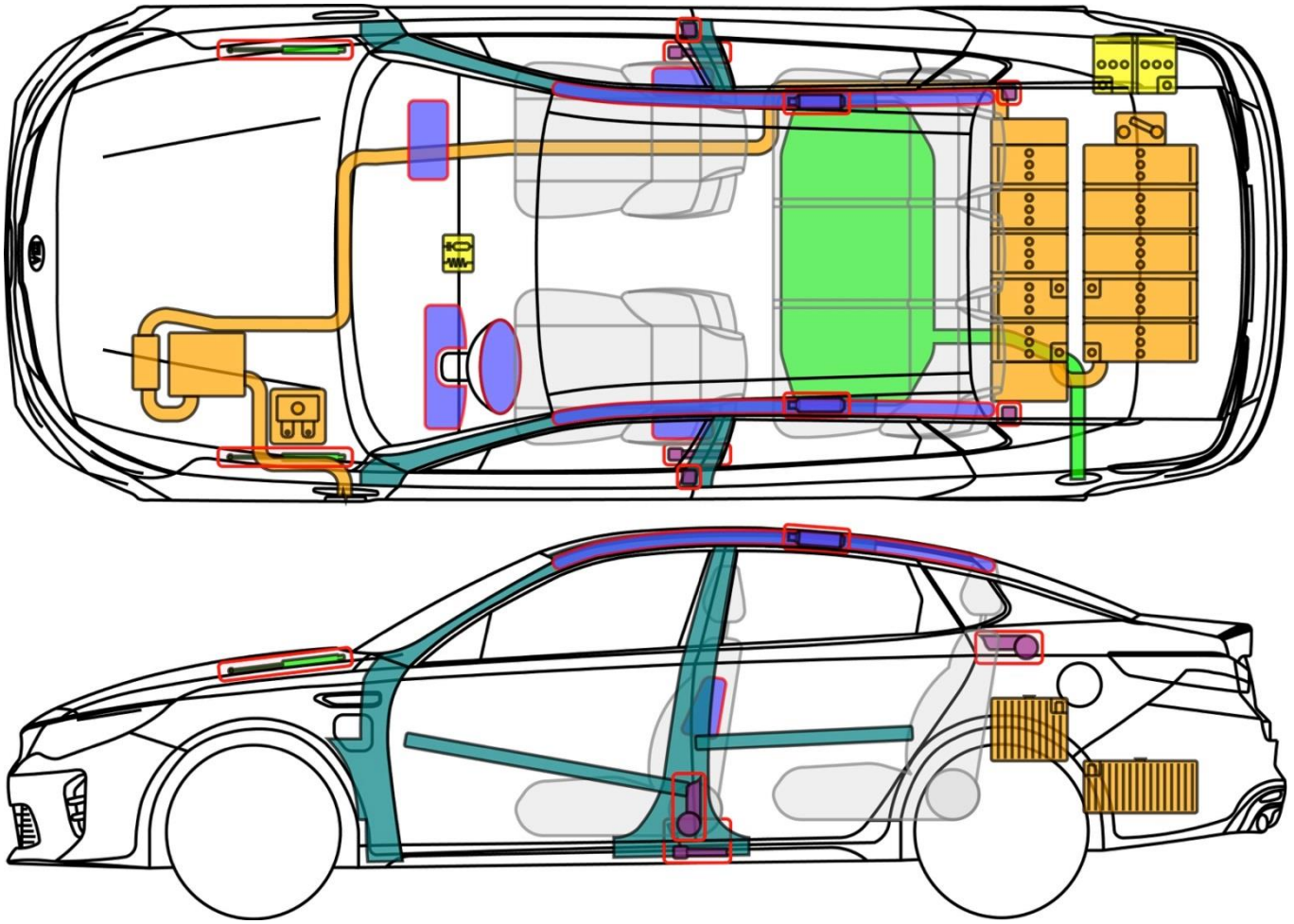

## Legende

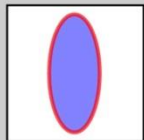

Airbag

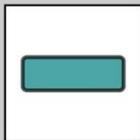

Karosserie-  
verstärkung



Steuergerät

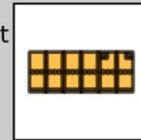

Hochvolt-  
batterie

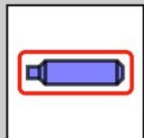

Gas-  
generator



Fußgänger-  
Schutz-  
system

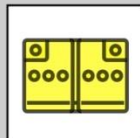

12 V  
Batterie

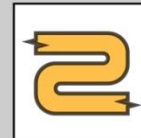

Hochvolt-  
leitung/  
-komponente

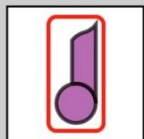

Gurt-  
straffer

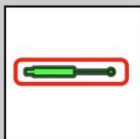

Gasdruck-  
dämpfer

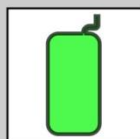

Kraftstoff-  
tank

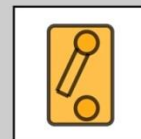

HV-  
Trennstelle

Optima







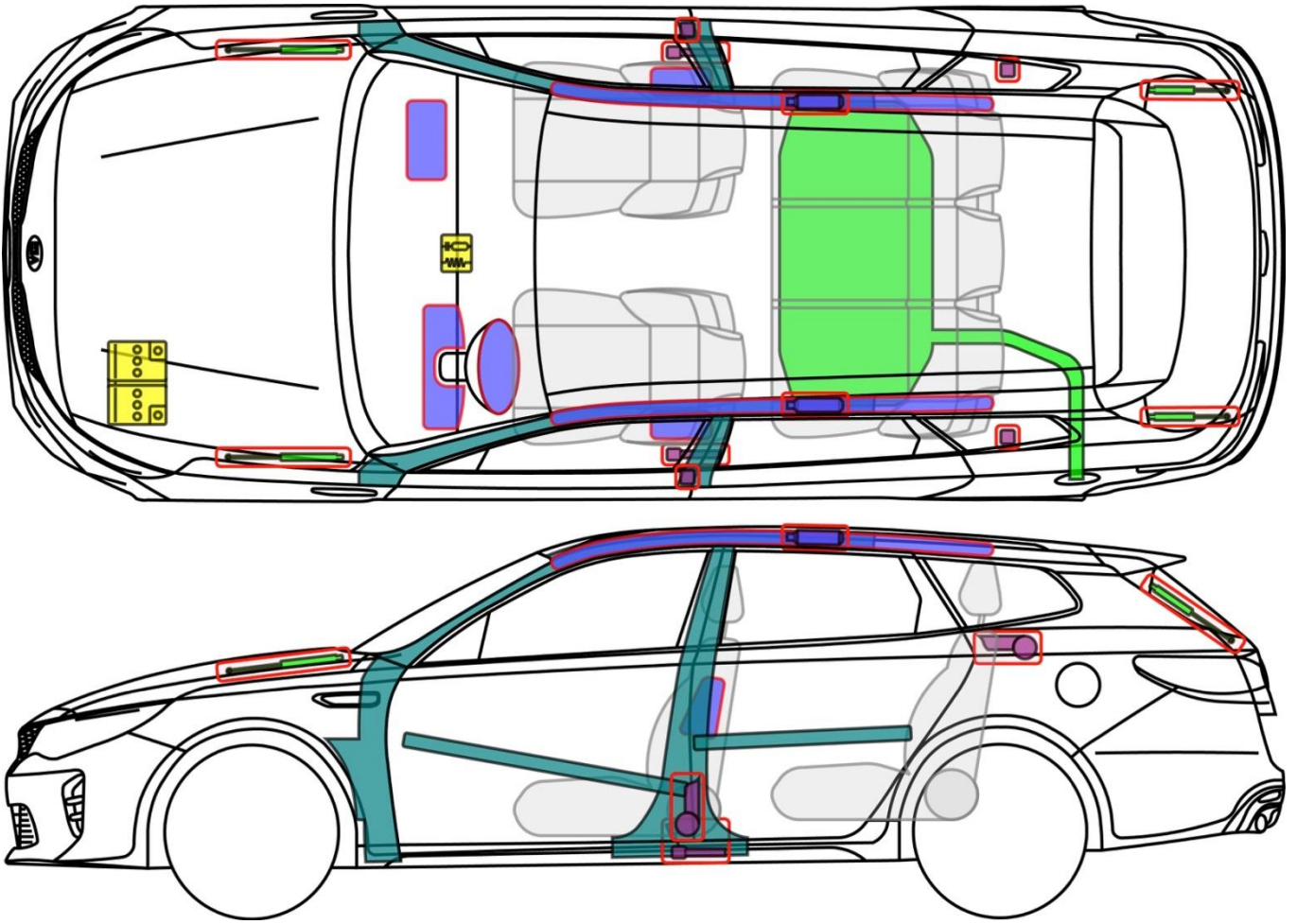

# Optima (JF)

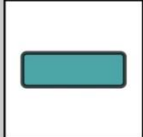
5-Türer ab 2016

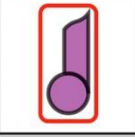

## Legende

	Airbag		Karosserie- verstärkung		Steuergerät
	Gas- generator		Fußgänger- Schutz- system		12 V Batterie
	Gurt- straffer		Gasdruck- dämpfer		Kraftstoff- tank

Optima



# Optima (JF)

Plug-in Hybrid,  
5-Türer ab 2017

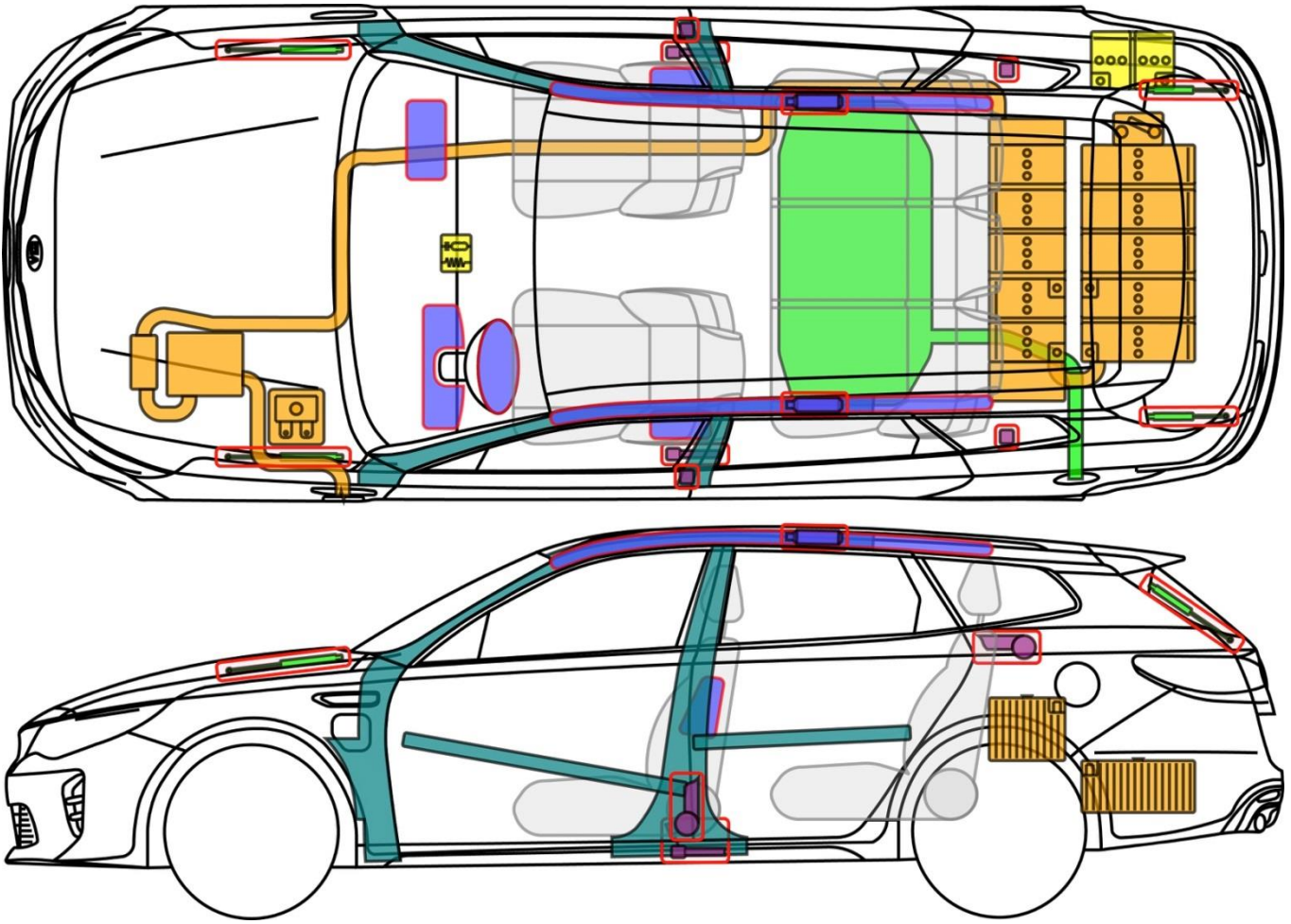

## Legende

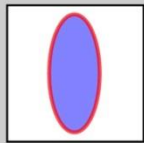

Airbag

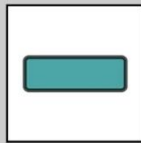

Karosserie-  
verstärkung



Steuergerät

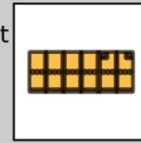

Hochvolt-  
batterie

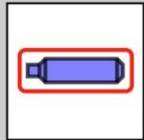

Gas-  
generator



Fußgänger-  
Schutz-  
system

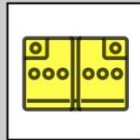

12 V  
Batterie



Hochvolt-  
leitung/  
-komponente



Gurt-  
straffer

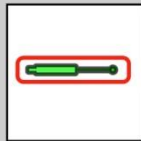

Gasdruck-  
dämpfer

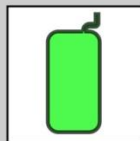

Kraftstoff-  
tank

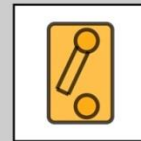

HV-  
Trennstelle

Optima



# Picanto (SA)

2004-2011

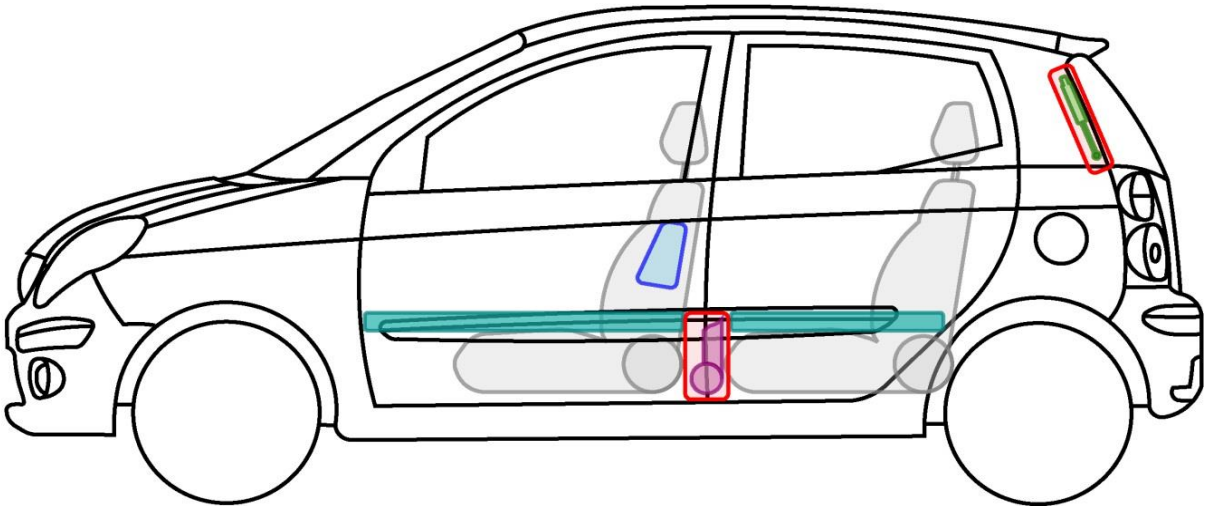
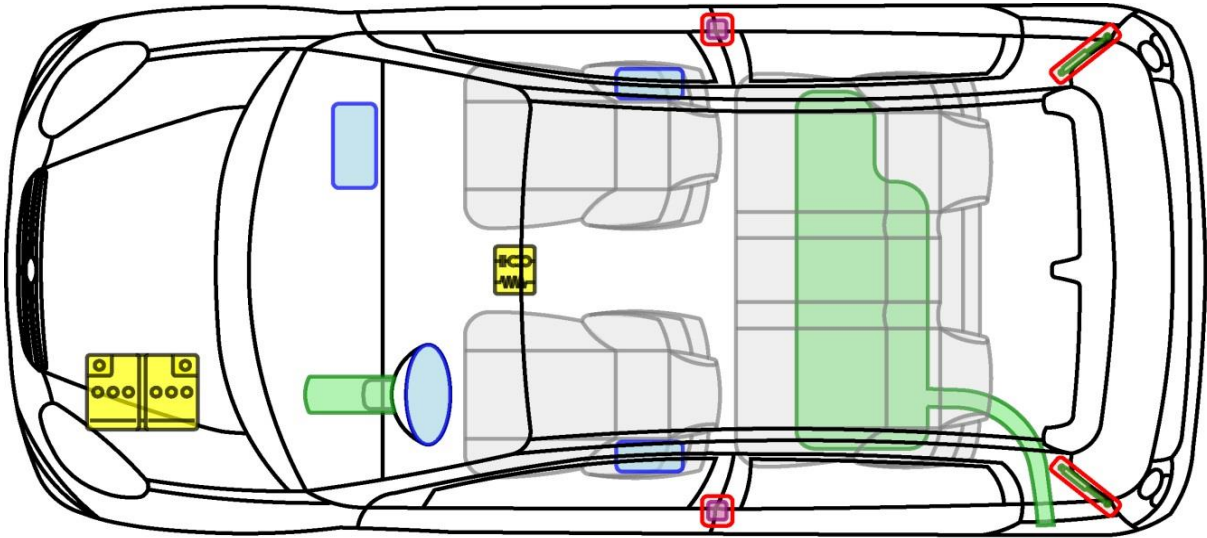

### Legende

	Airbag		Karosserie- verstärkung		Steuergerät
	Gas- generator		Überroll- schutz		Batterie
	Gurt- straffer		Gasdruck- dämpfer		Kraftstoff- tank

Picanto







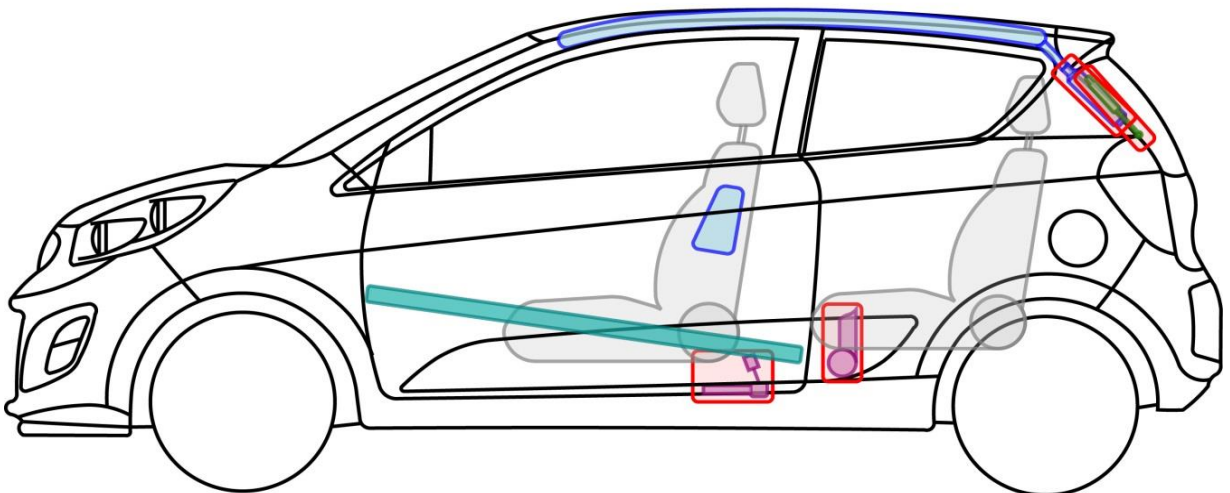
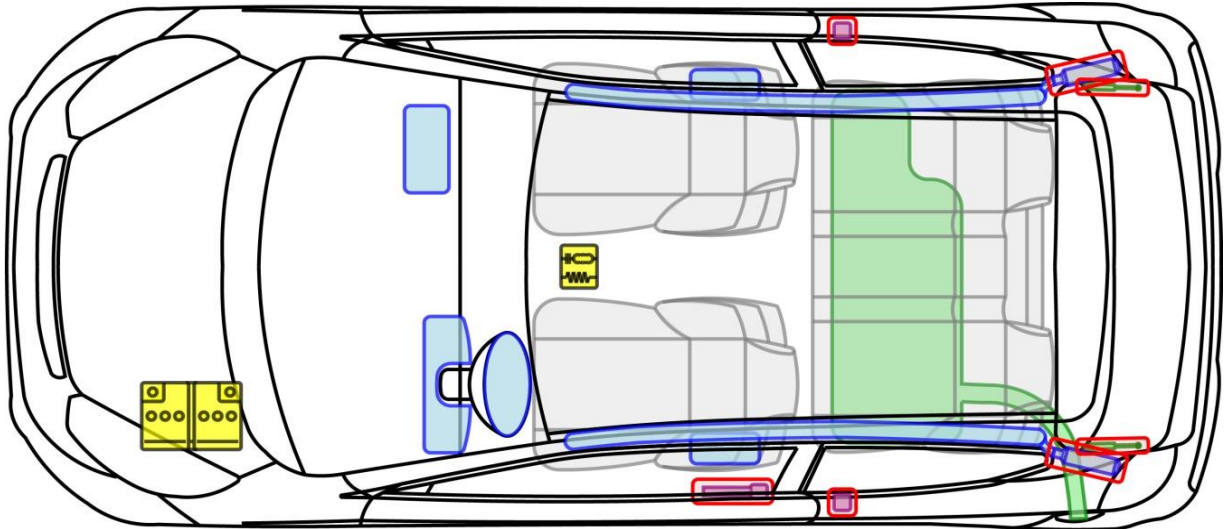



# Picanto (TA)

3-Türer, 2011-2017  
inklusive Facelift



## Legende

	Airbag		Karosserie- verstärkung		Steuergerät
	Gas- generator		Überroll- schutz		Batterie
	Gurt- straffer		Gasdruck- dämpfer		Kraftstoff- tank

Picanto







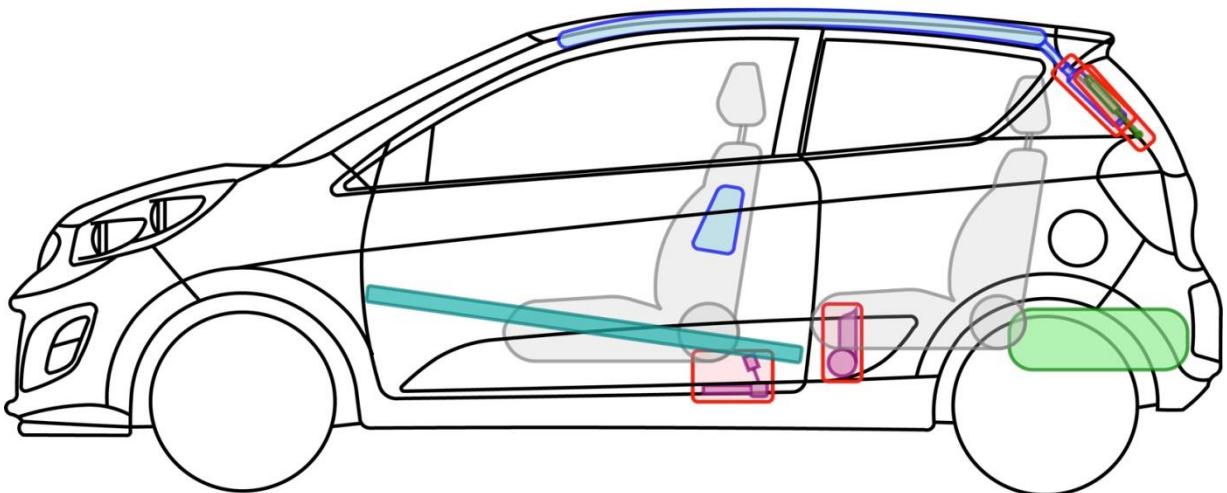
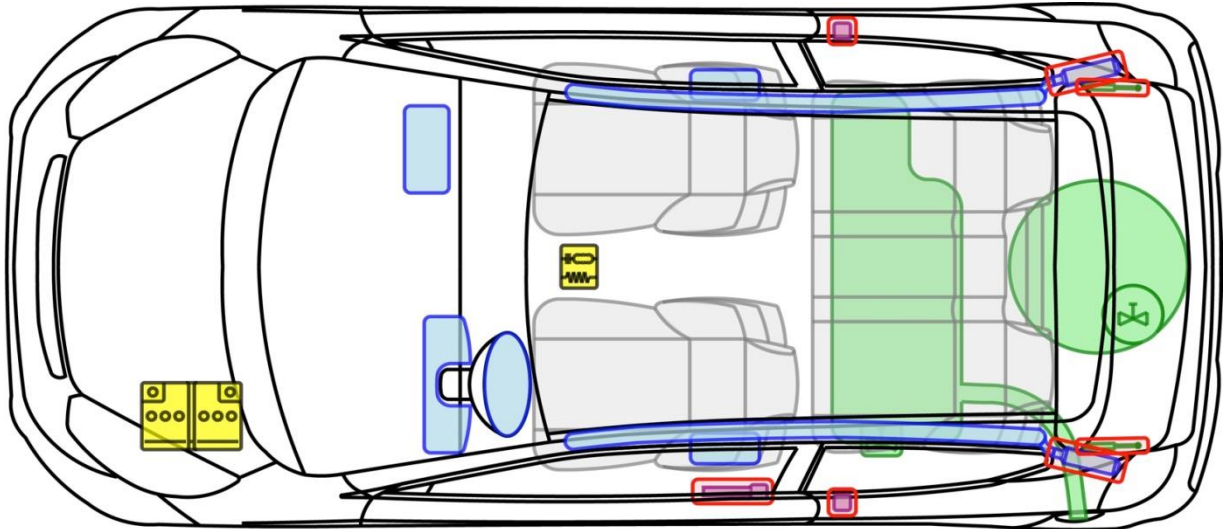

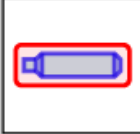

# Picanto (TA)

3-Türer, LPG, 2011-2017  
inklusive Facelift

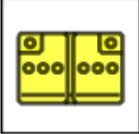

## Legende

	Airbag		Karosserie- verstärkung		Steuergerät
	Gas- generator		Überroll- schutz		Batterie
	Gurt- straffer		Gasdruck- dämpfer		Kraftstoff- tank

Picanto







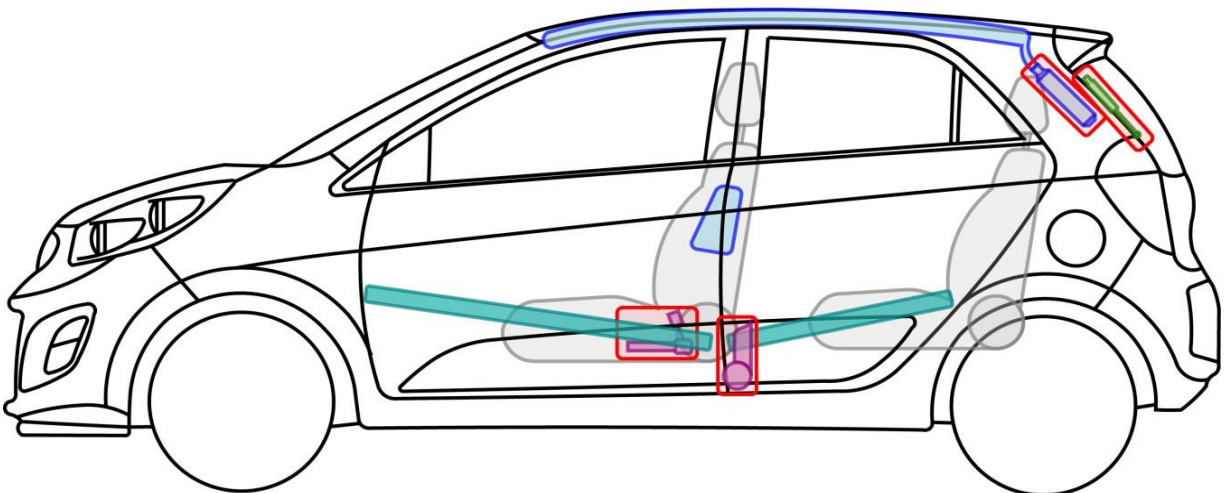
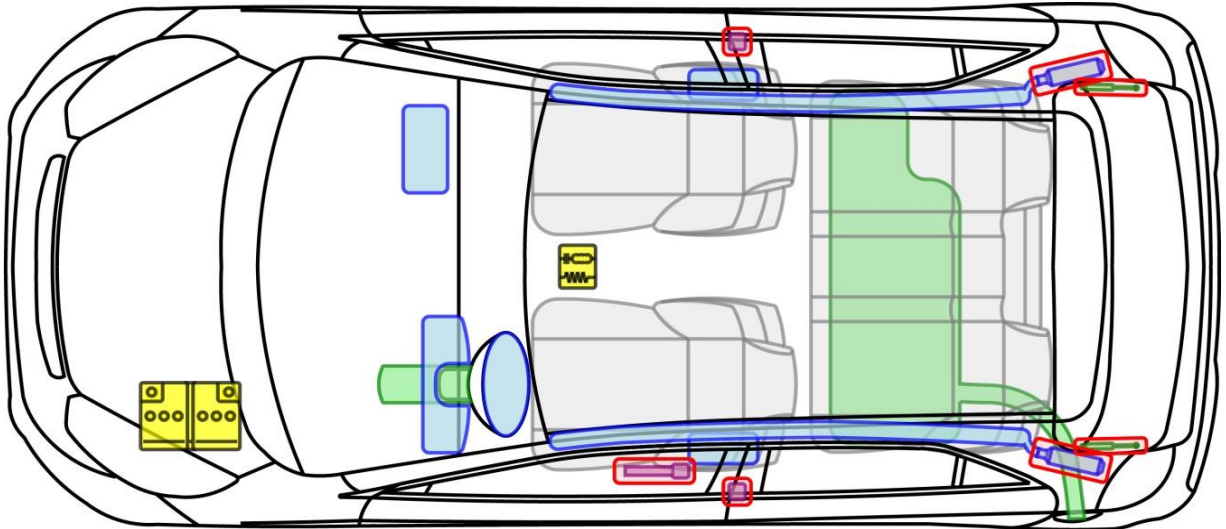

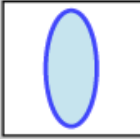

# Picanto (TA)

5-Türer, 2011-2017  
inklusive Facelift

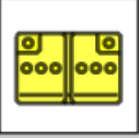

## Legende

	Airbag		Karosserie- verstärkung		Steuergerät
	Gas- generator		Überroll- schutz		Batterie
	Gurt- straffer		Gasdruck- dämpfer		Kraftstoff- tank

Picanto





# Picanto (TA)

5-Türer, LPG, 2011-2017  
inklusive Facelift

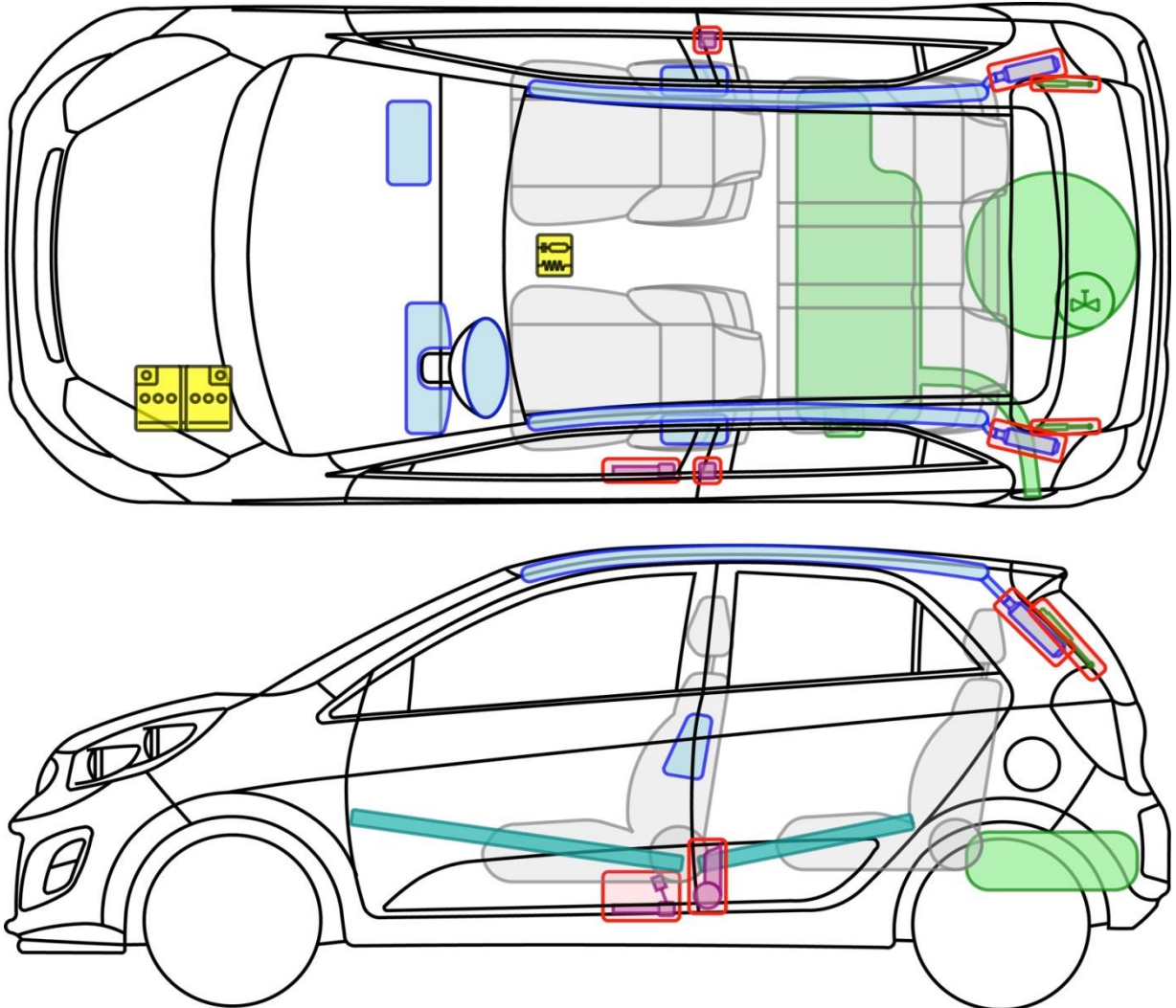

## Legende

	Airbag		Karosserie- verstärkung		Steuergerät
	Gas- generator		Überroll- schutz		Batterie
	Gurt- straffer		Gasdruck- dämpfer		Kraftstoff- tank

Picanto







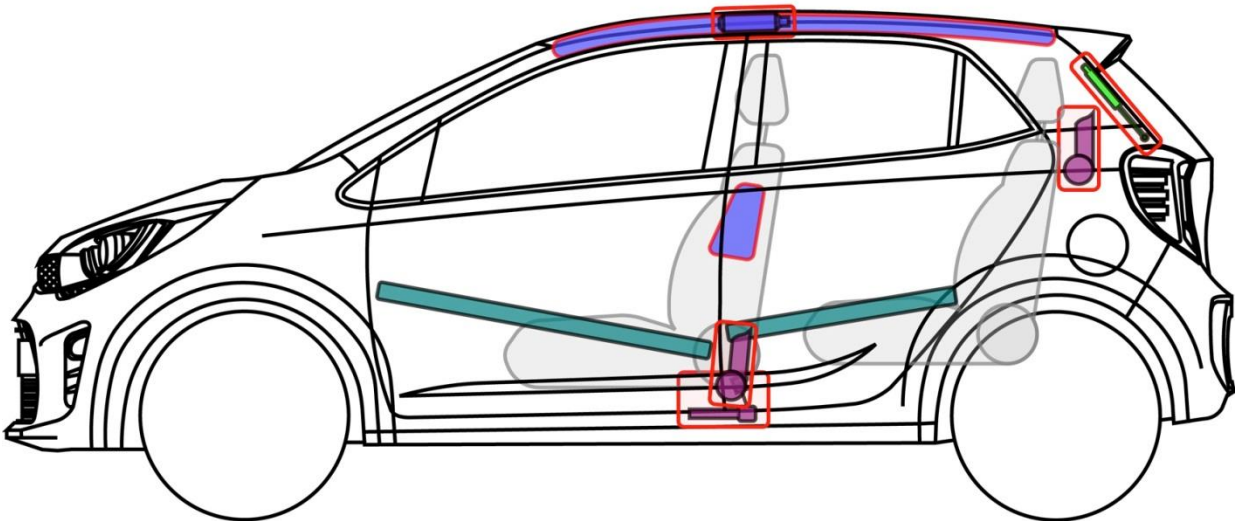
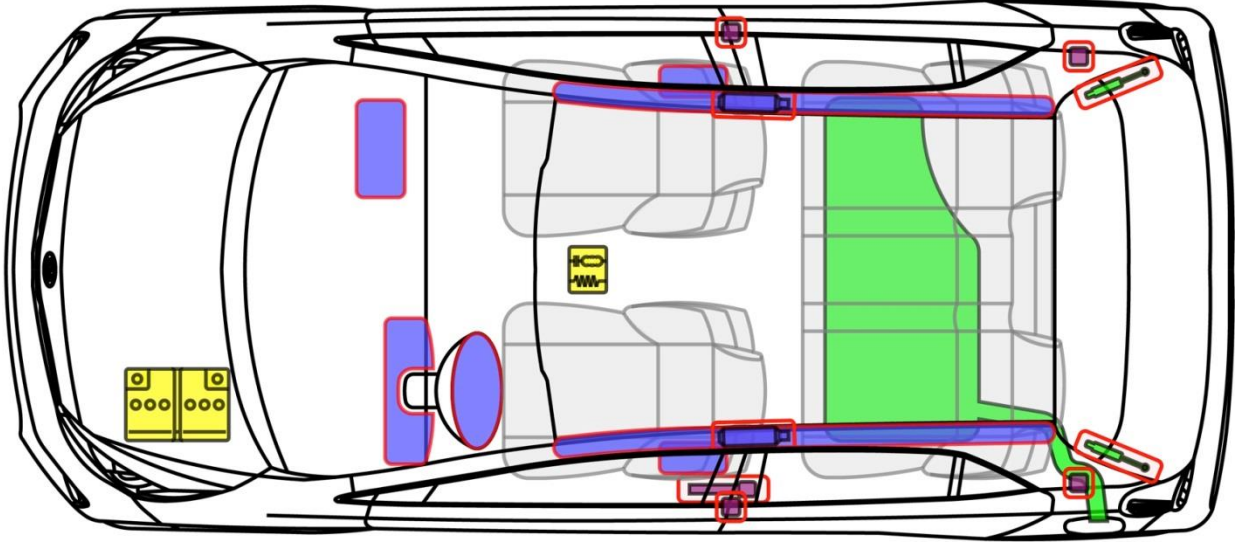

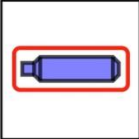

# Picanto (JA)

5-Türer, ab 2017



## Legende

	Airbag		Karosserie- verstärkung		Steuergerät
	Gas- generator		Fußgänger- Schutz- system		12 V Batterie
	Gurt- straffer		Gasdruck- dämpfer		Kraftstoff- tank

Picanto



# Rio (JB) 2005-2011

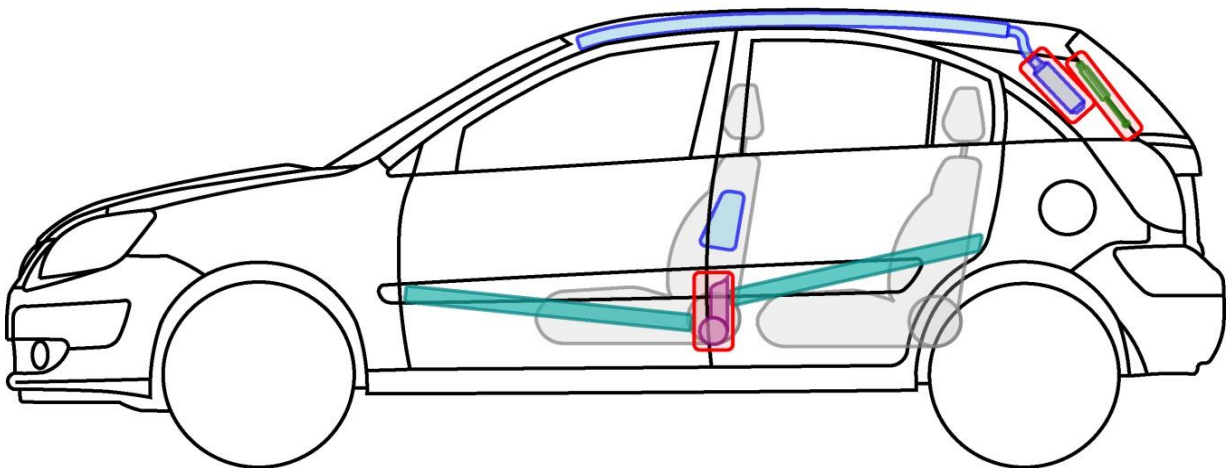
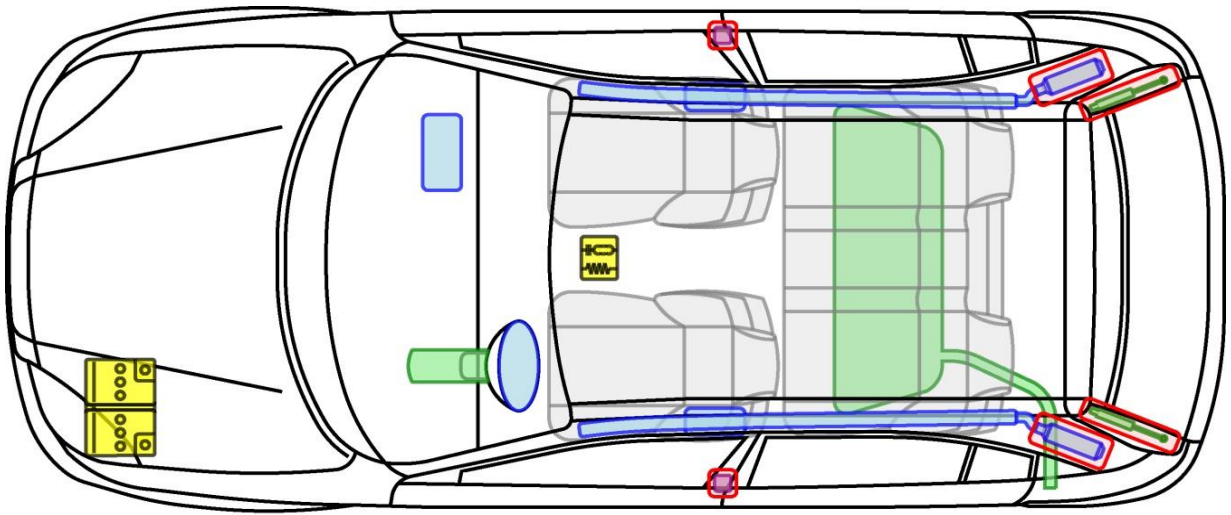

## Legende

	Airbag		Karosserie- verstärkung		Steuergerät
	Gas- generator		Überroll- schutz		Batterie
	Gurt- straffer		Gasdruck- dämpfer		Kraftstoff- tank

Rio



# Rio (UB)

3-Türer, 2011-2017  
inklusive Facelift

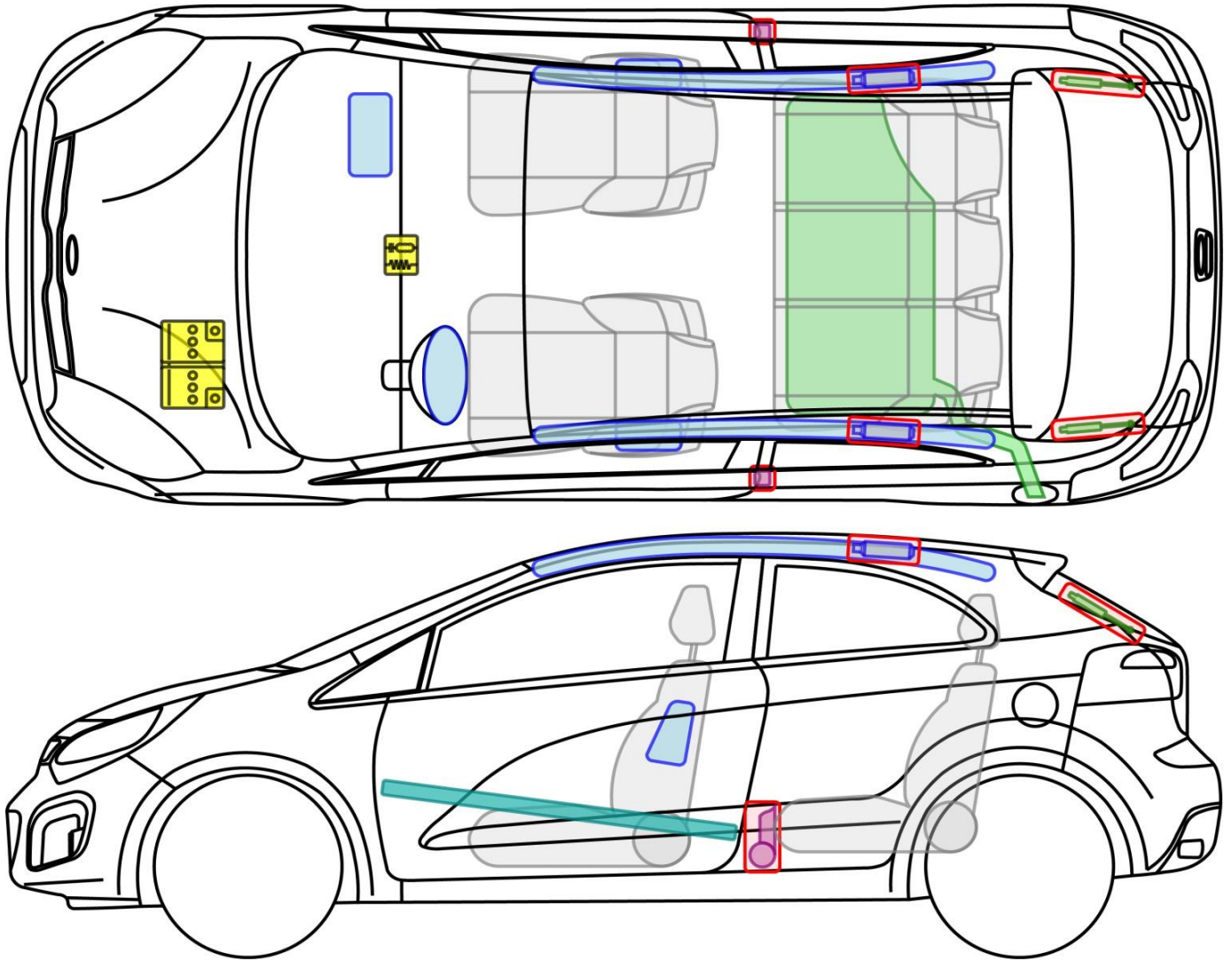

## Legende

	Airbag		Karosserie-verstärkung		Steuergerät
	Gas-generator		Überroll-schutz		Batterie
	Gurt-straffer		Gasdruck-dämpfer		Kraftstoff-tank

Rio



# Rio (UB)

5-Türer, 2011-2017  
inklusive Facelift

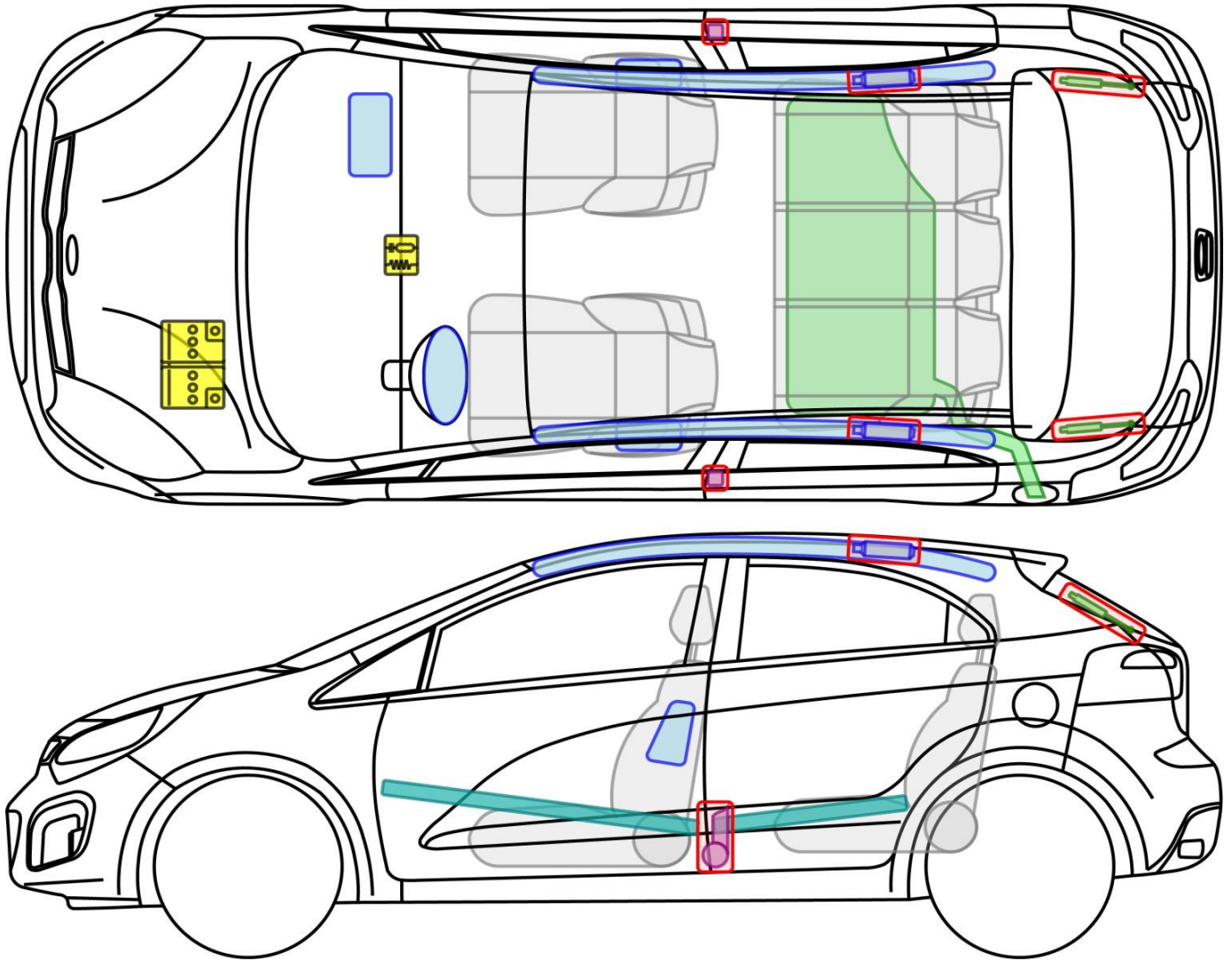

## Legende

	Airbag		Karosserie-verstärkung		Steuergerät
	Gas-generator		Überroll-schutz		Batterie
	Gurt-straffer		Gasdruck-dämpfer		Kraftstoff-tank

Rio



# Rio (YB)

5-Türer, ab 2017

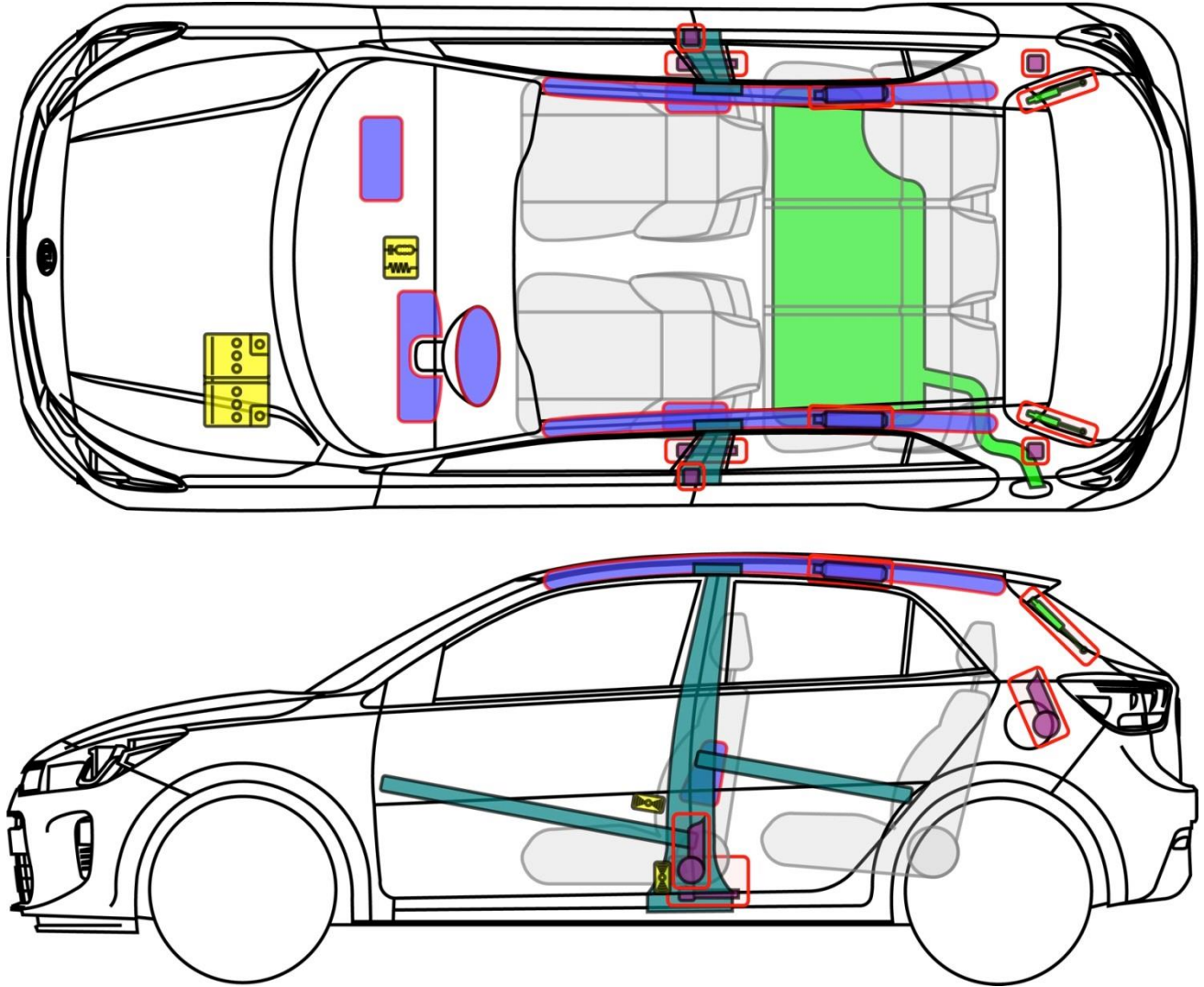

## Legende

	Airbag		Karosserie- verstärkung		Steuergerät
	Gas- generator		Fußgänger- Schutz- system		12 V Batterie
	Gurt- straffer		Gasdruck- dämpfer		Kraftstoff- tank

Rio



# Sorento (BL)

2002-2006

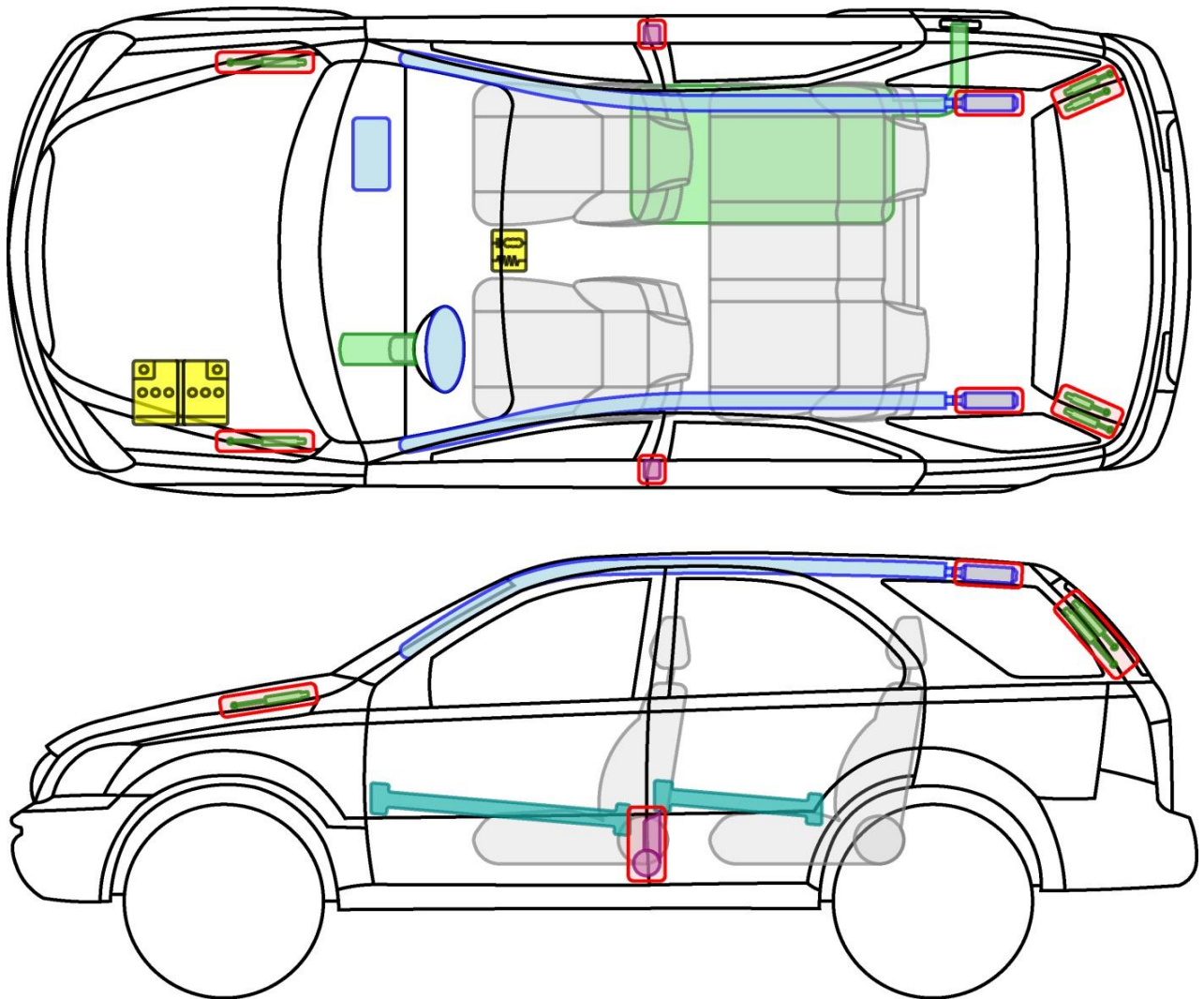

## Legende

	Airbag		Karosserie-verstärkung		Steuergerät
	Gas-generator		Überroll-schutz		Batterie
	Gurt-straffer		Gasdruck-dämpfer		Kraftstoff-tank



# Sorento (BL)

2006-2009

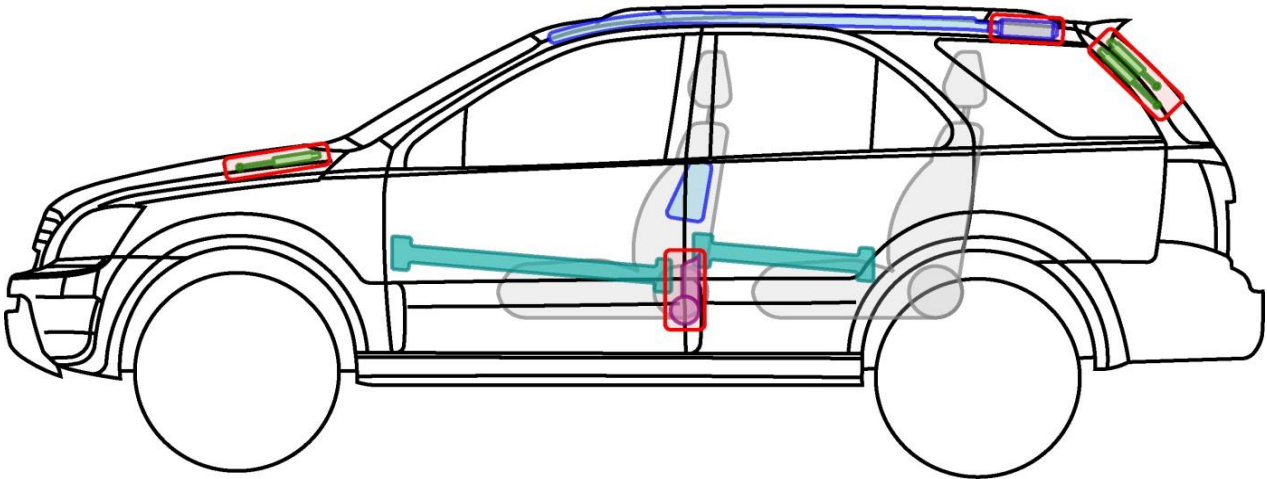
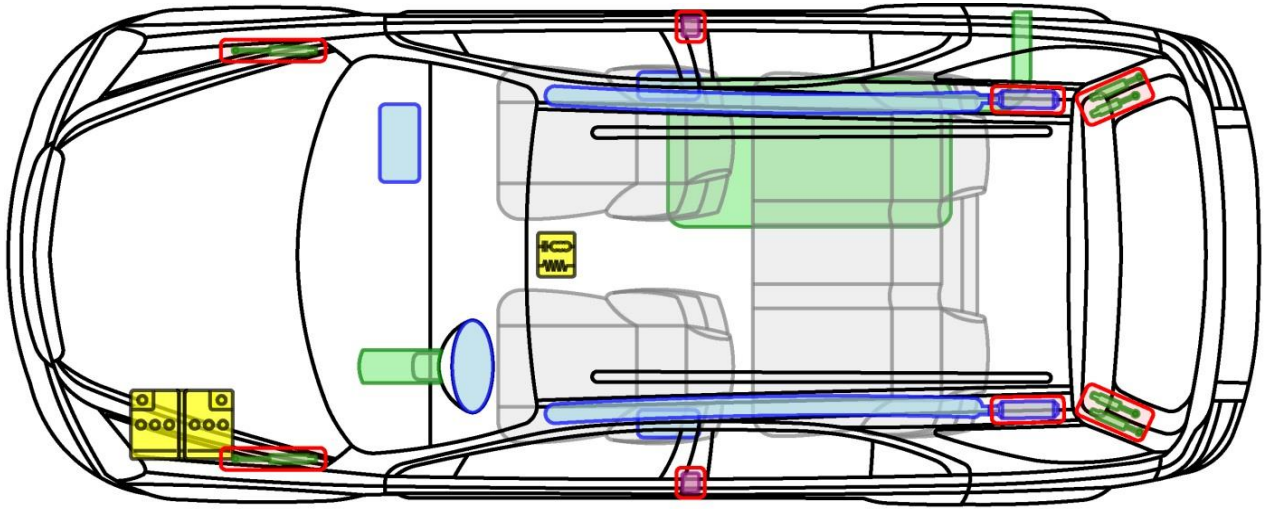

### Legende

	Airbag		Karosserie-verstärkung		Steuergerät
	Gas-generator		Überroll-schutz		Batterie
	Gurt-straffer		Gasdruck-dämpfer		Kraftstoff-tank

Sorento





# Sorento (XM)

2009-2014

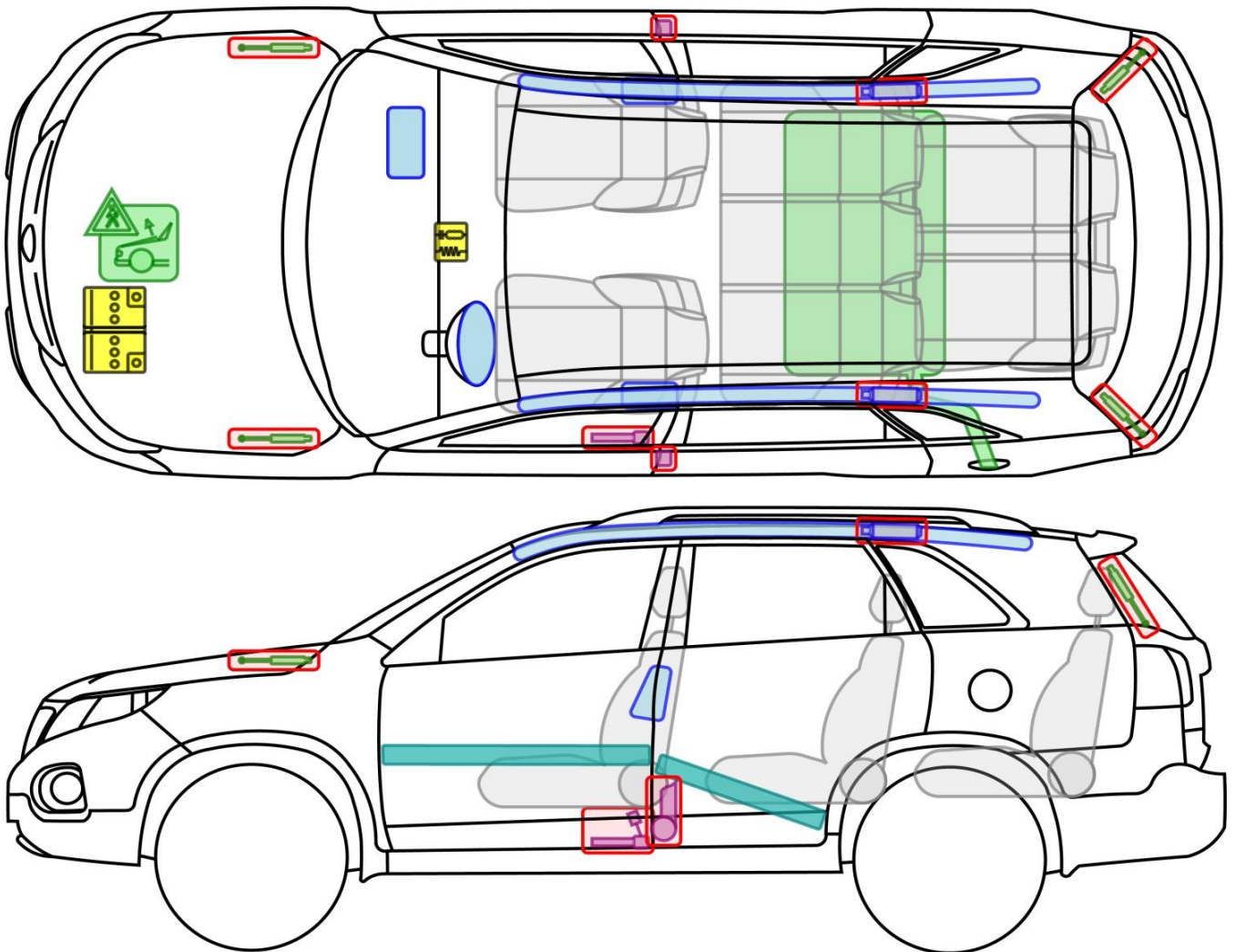

## Legende

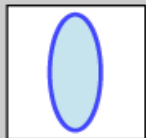

Airbag



Karosserie-  
verstärkung



Steuergerät



Fußgänger-  
schutz-  
system

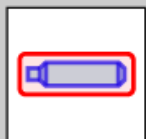

Gas-  
generator



Überroll-  
schutz

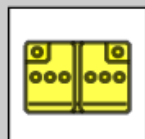

Batterie



Gurt-  
straffer



Gasdruck-  
dämpfer



Kraftstoff-  
tank

Sorento



# Sorento (UM)

ab 2014

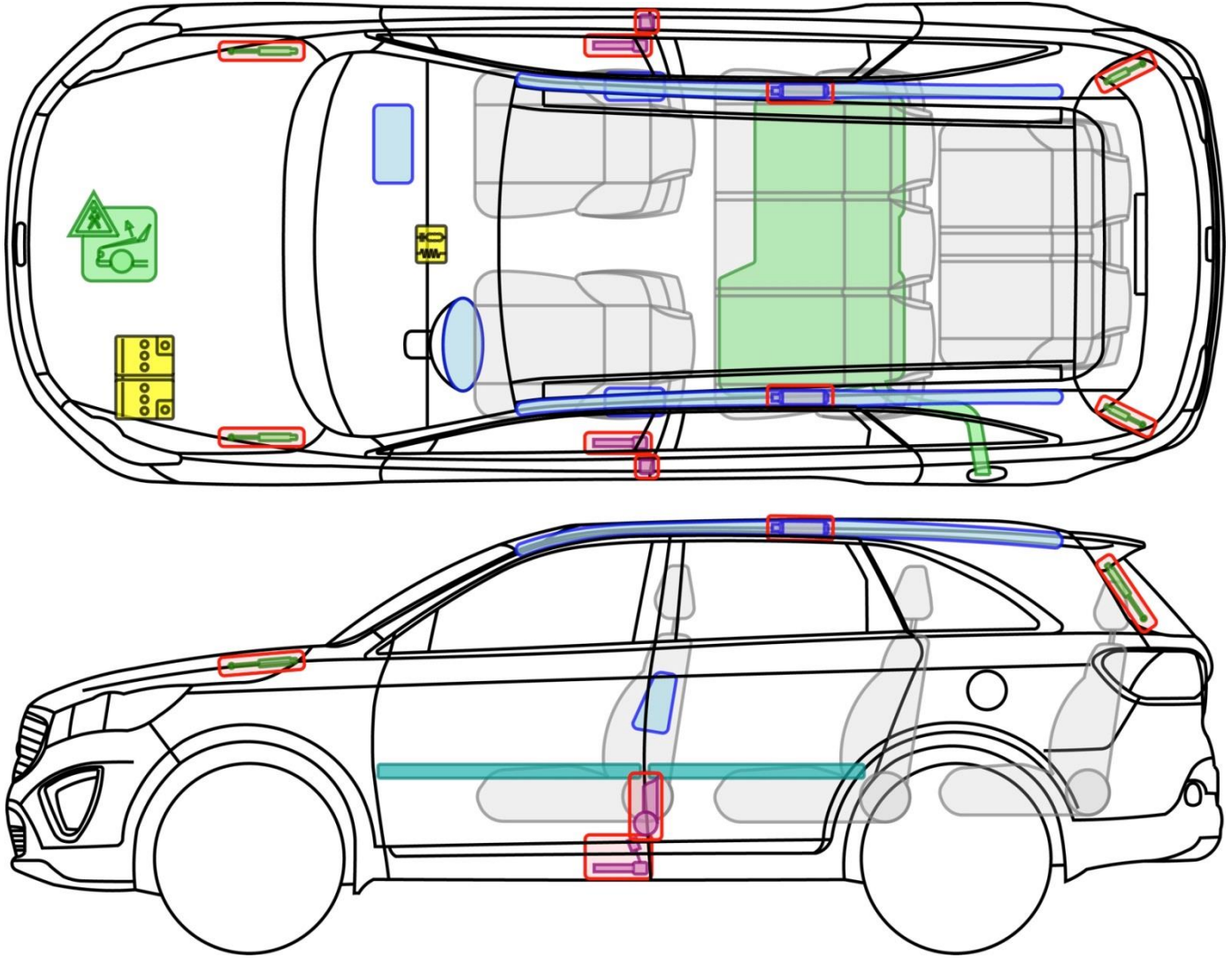

## Legende

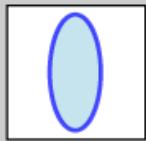

Airbag



Karosserie-  
verstärkung



Steuergerät



Fußgänger-  
schutz-  
system



Gas-  
generator



Überroll-  
schutz

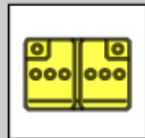

Batterie



Gurt-  
straffer



Gasdruck-  
dämpfer



Kraftstoff-  
tank

Sorento



# Soul (AM)

2009-2014

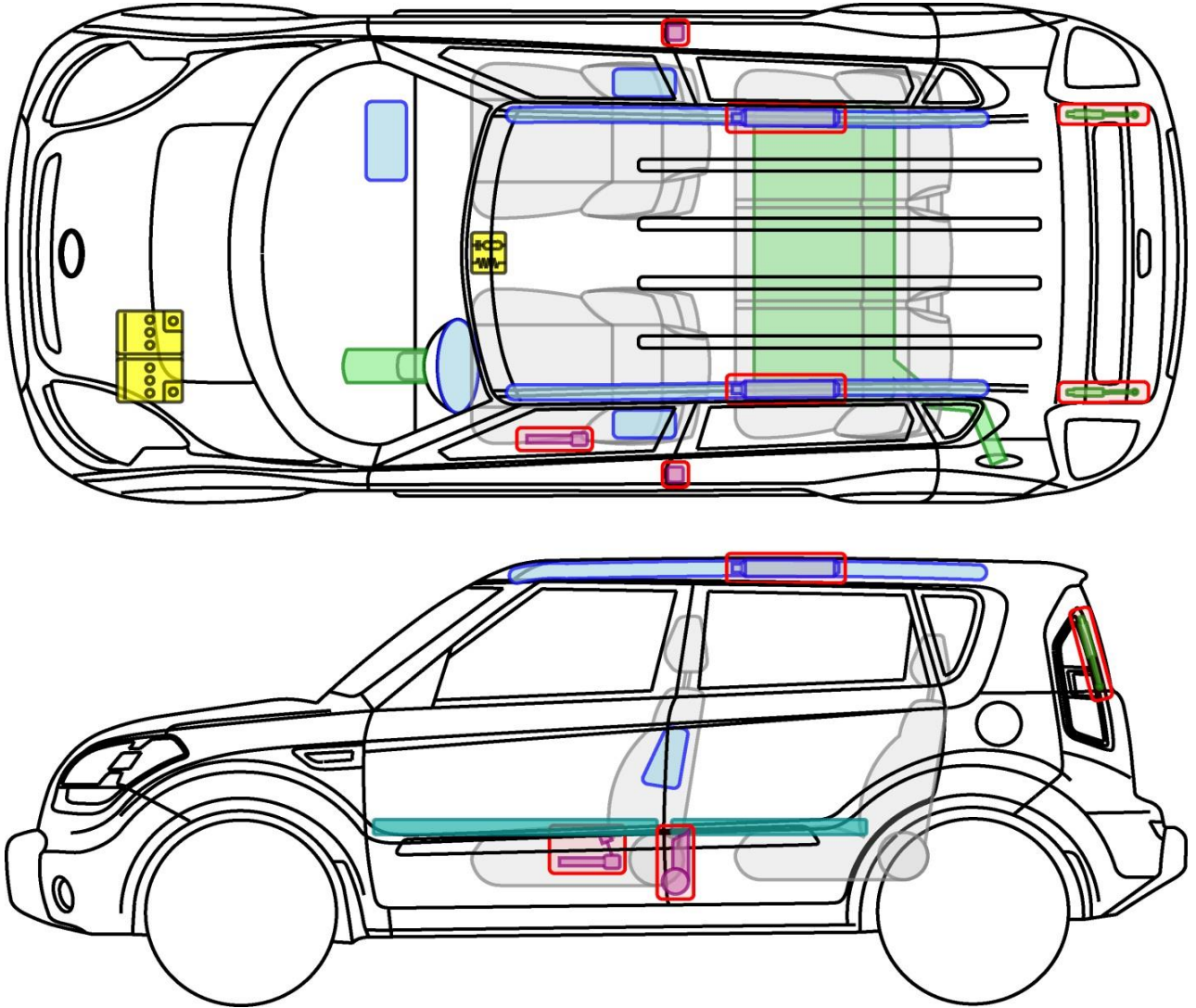

## Legende

	Airbag		Karosserie-verstärkung		Steuergerät
	Gas-generator		Überroll-schutz		Batterie
	Gurt-traffer		Gasdruck-dämpfer		Kraftstoff-tank



# Soul (PS) 2014-2019

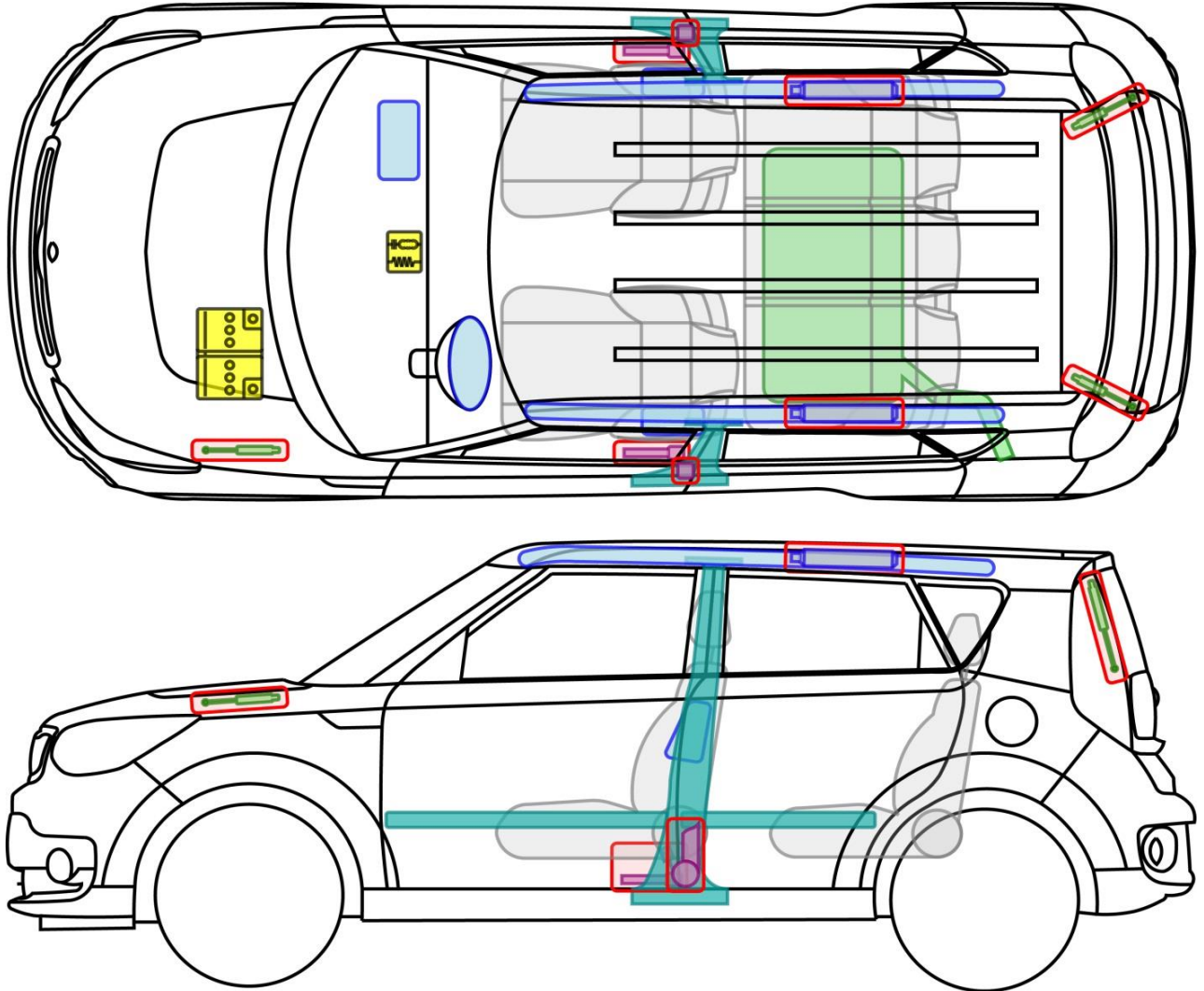

## Legende

	Airbag		Karosserie- verstärkung		Steuergerät
	Gas- generator		Überroll- schutz		Batterie
	Gurt- straffer		Gasdruck- dämpfer		Kraftstoff- tank

Soul



# Soul EV (PS EV)

2014-2019

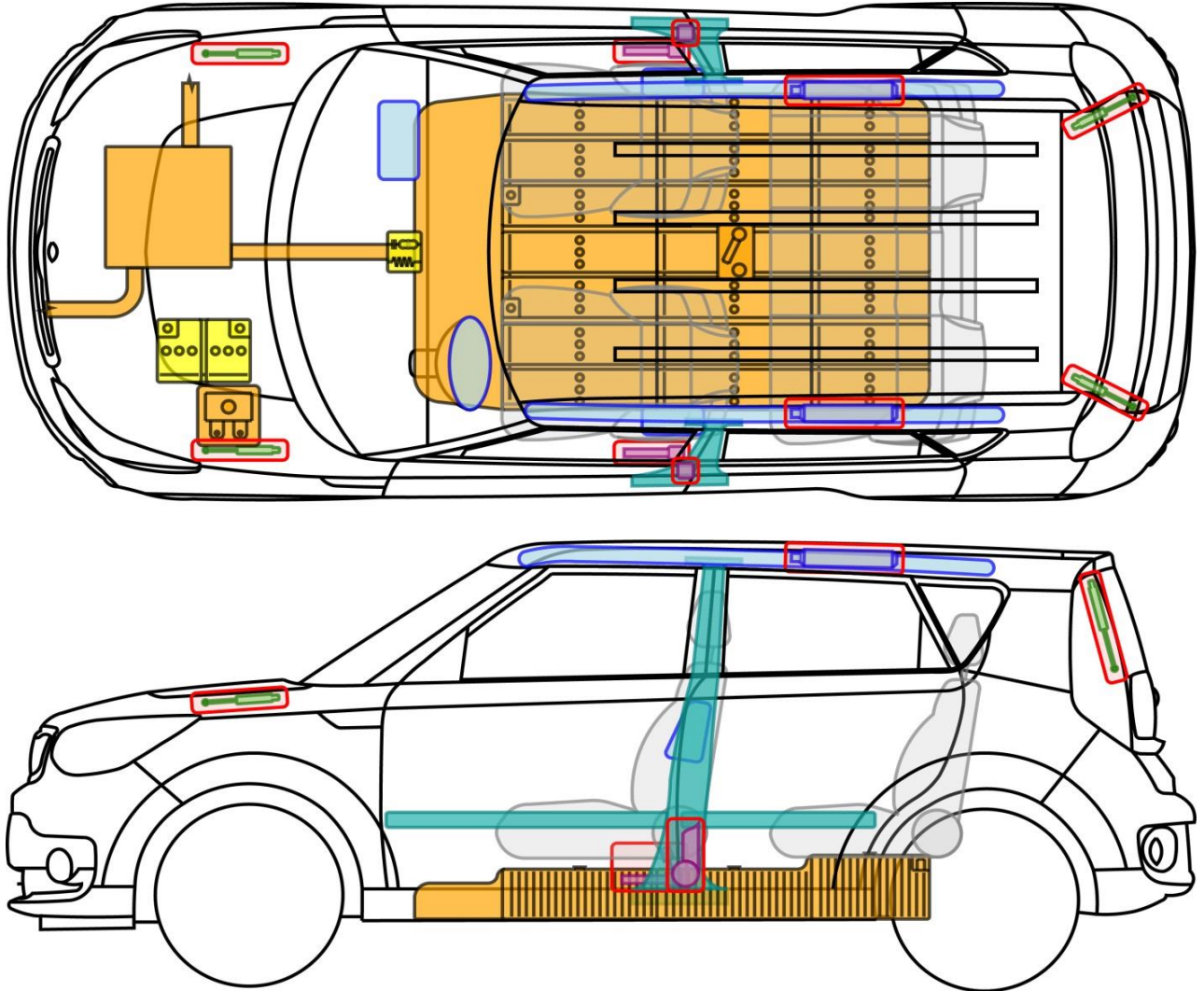

## Legende

	Airbag		Karosserie- verstärkung		Steuergerät		Hochvolt- batterie
	Gas- generator		Überroll- schutz		12 V Batterie		Hochvolt- leitung/ -komponente
	Gurt- straffer		Gasdruck- dämpfer		Kraftstoff- tank		HV- Trennstelle

Soul EV



# Soul EV (SK3)

ab 2019

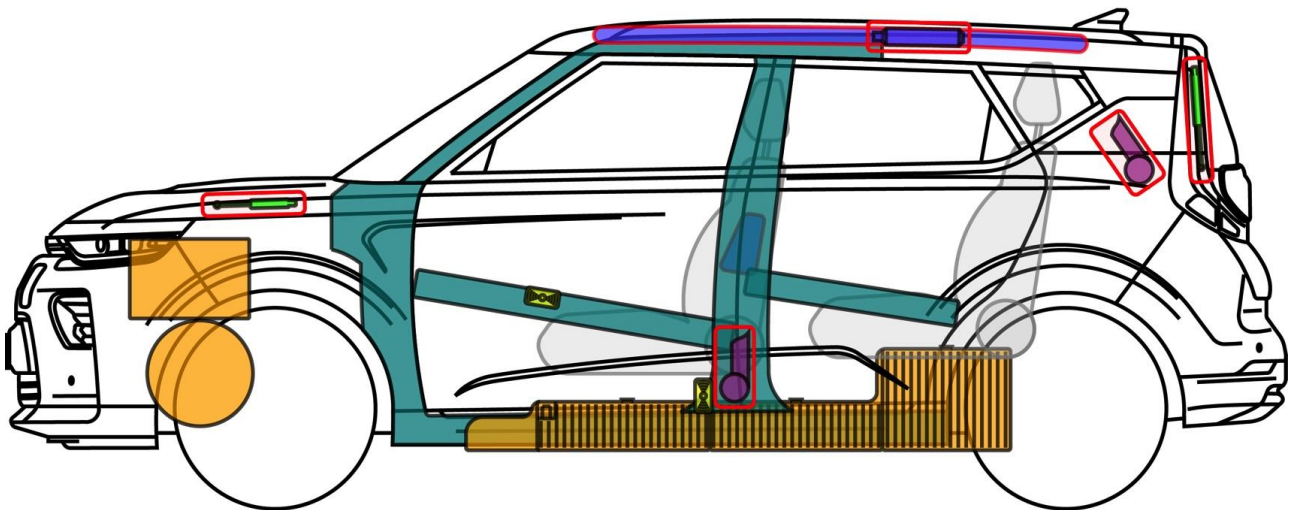
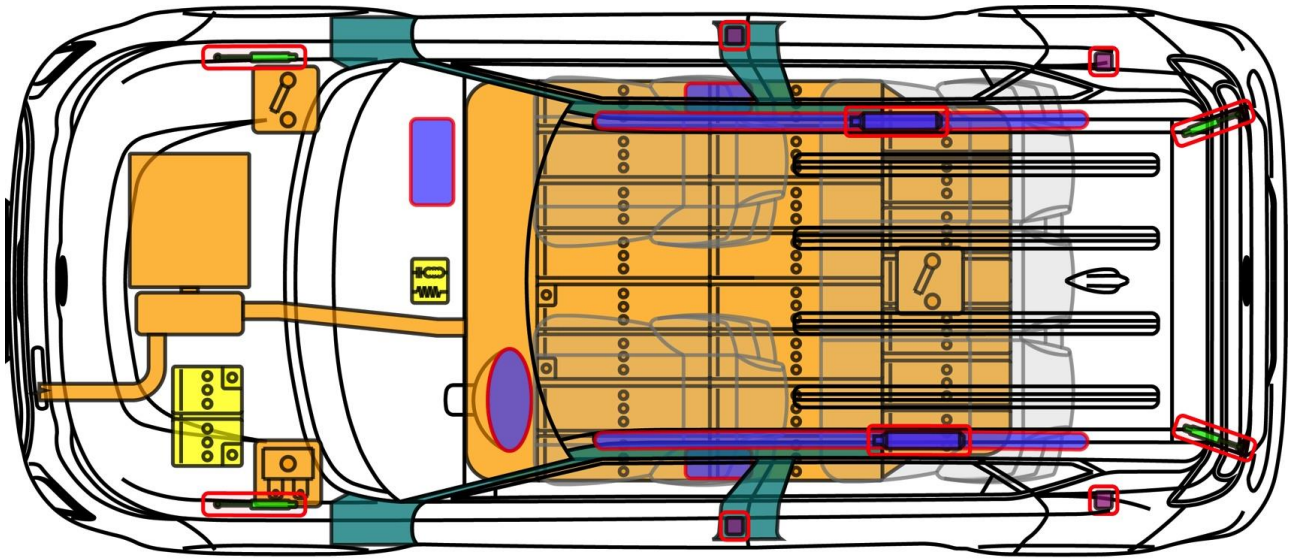

## Legende

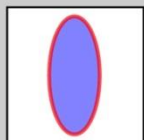

Airbag

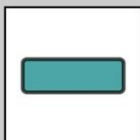

Karosserie-  
verstärkung



Steuergerät



Hochvolt-  
batterie

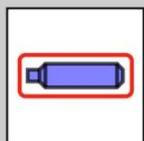

Gas-  
generator



Fußgänger-  
Schutz-  
system

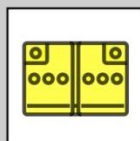

12 V  
Batterie



Hochvolt-  
leitung/  
-komponente

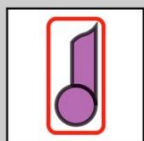

Gurt-  
straffer

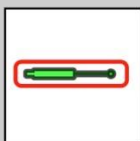

Gasdruck-  
dämpfer

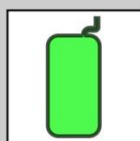

Kraftstoff-  
tank

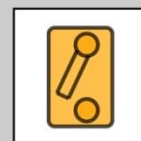

HV-  
Trennstelle

Soul EV



# Sportage (KM/JES)

2004-2010

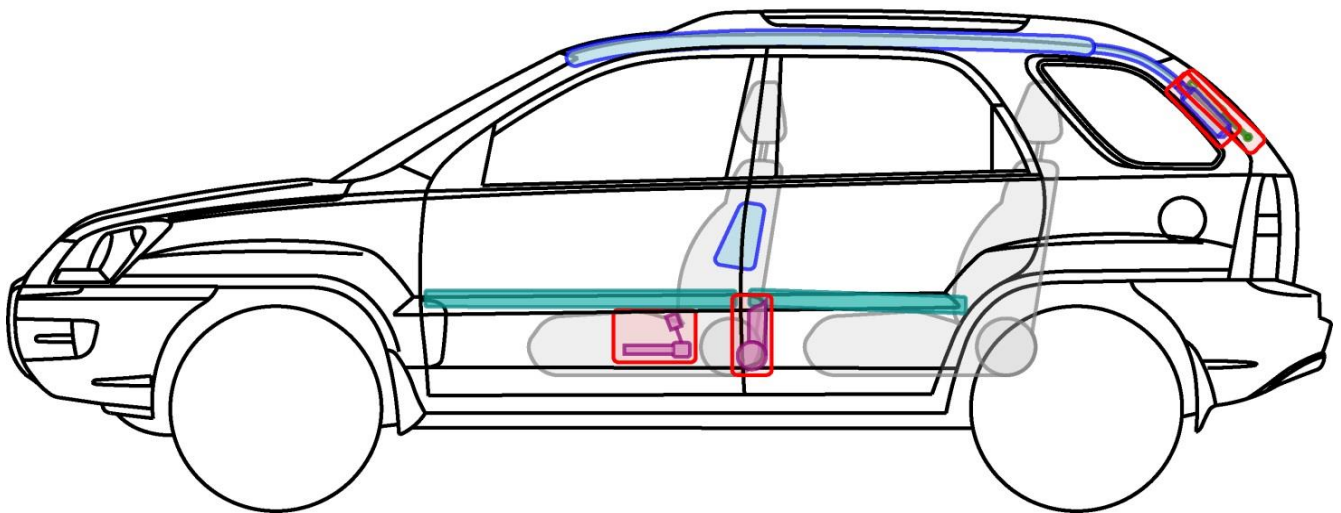
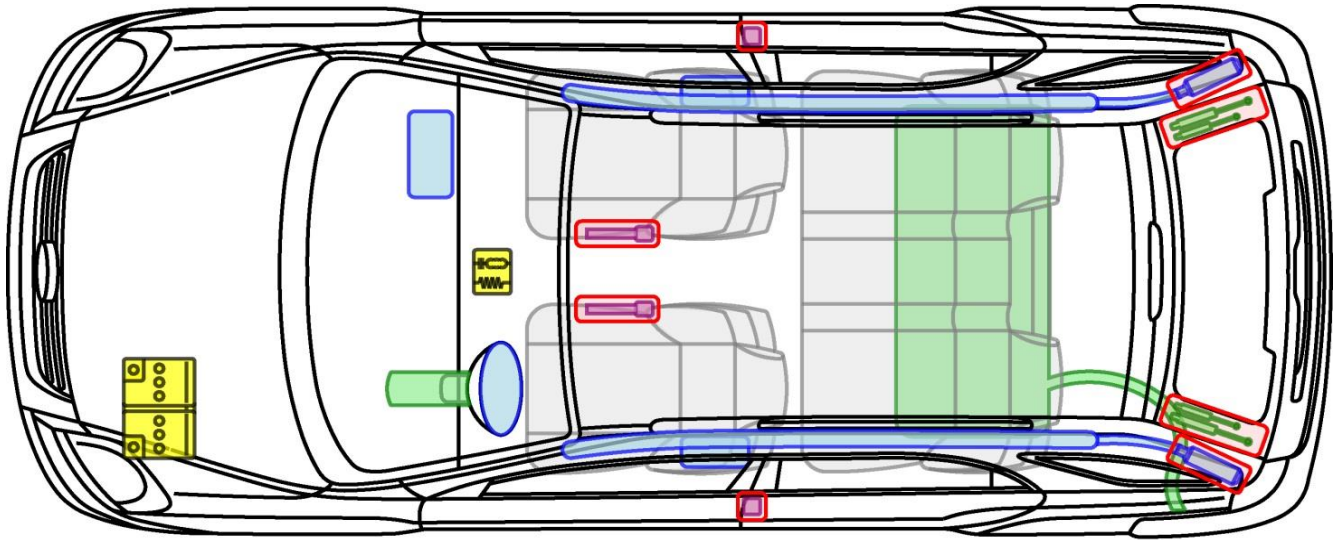

## Legende

	Airbag		Karosserie-verstärkung		Steuergerät
	Gas-generator		Überroll-schutz		Batterie
	Gurt-straffer		Gasdruck-dämpfer		Kraftstoff-tank



# Sportage (SL)

2010-2016  
inklusive Facelift

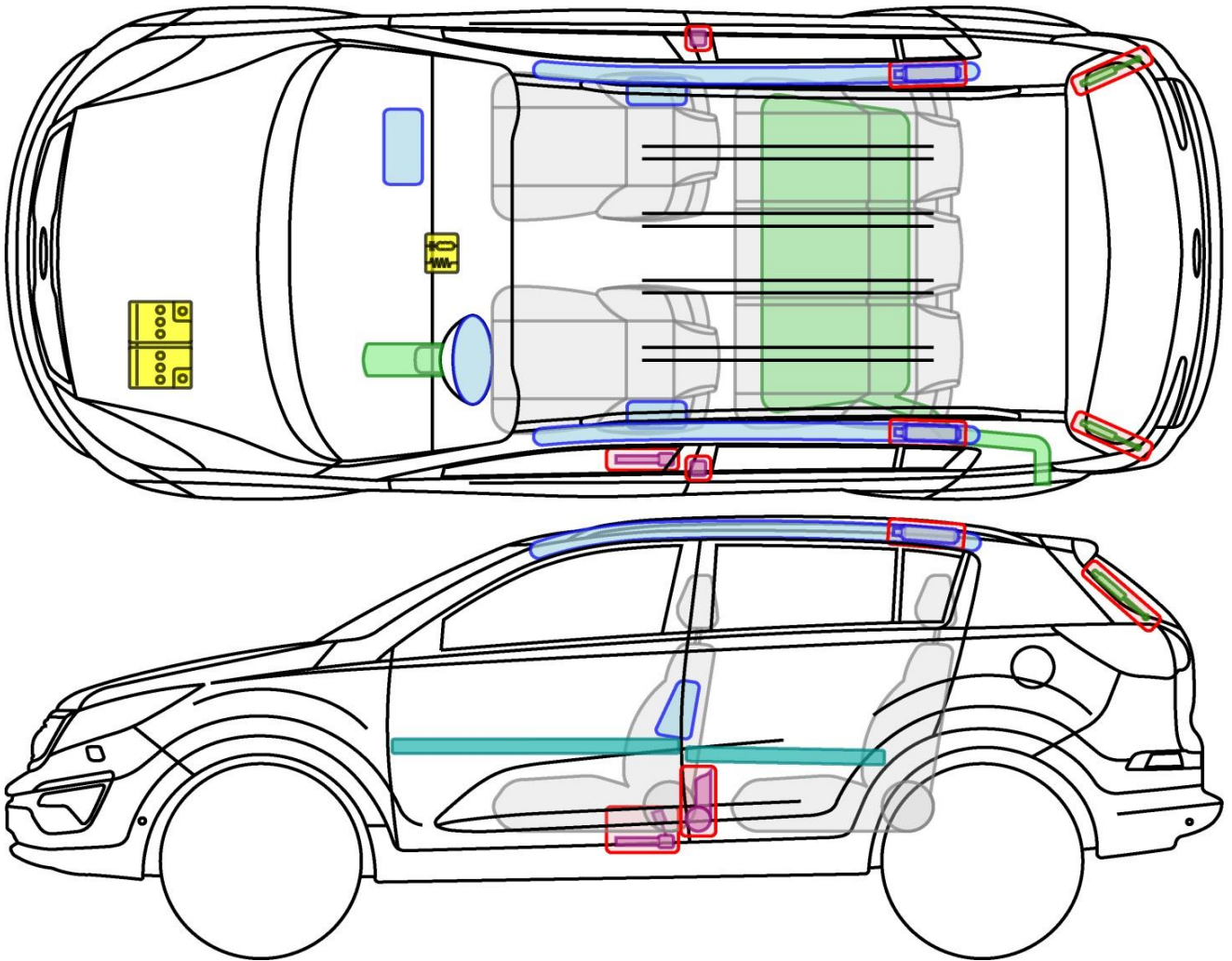

## Legende

	Airbag		Karosserie- verstärkung		Steuergerät
	Gas- generator		Überroll- schutz		Batterie
	Gurt- straffer		Gasdruck- dämpfer		Kraftstoff- tank

Sportage





# Sportage (QL)

ab 2016

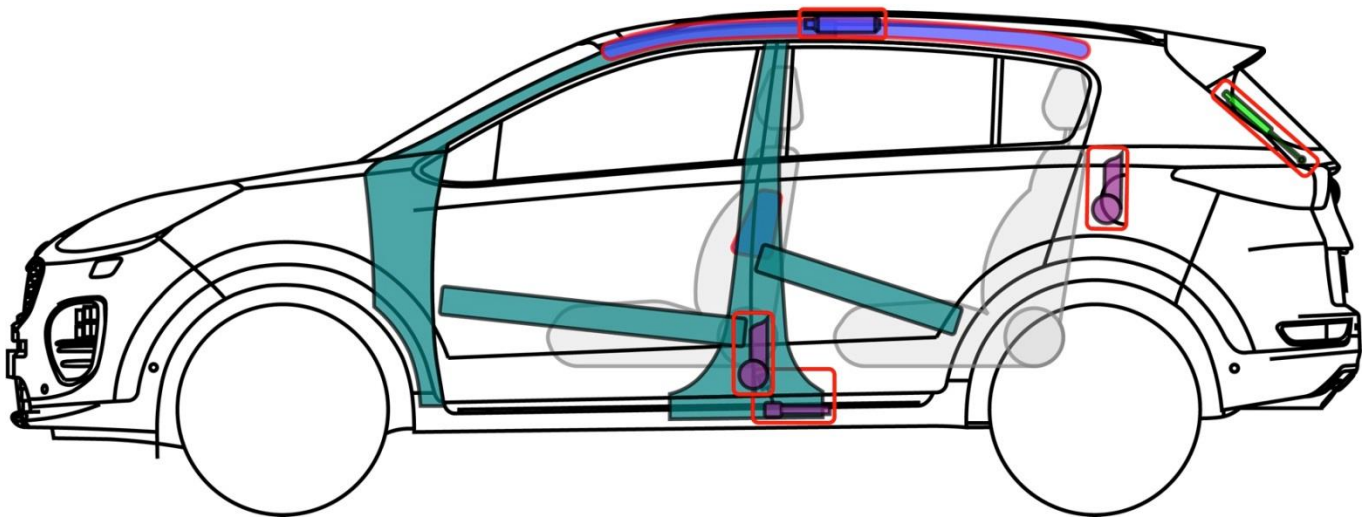
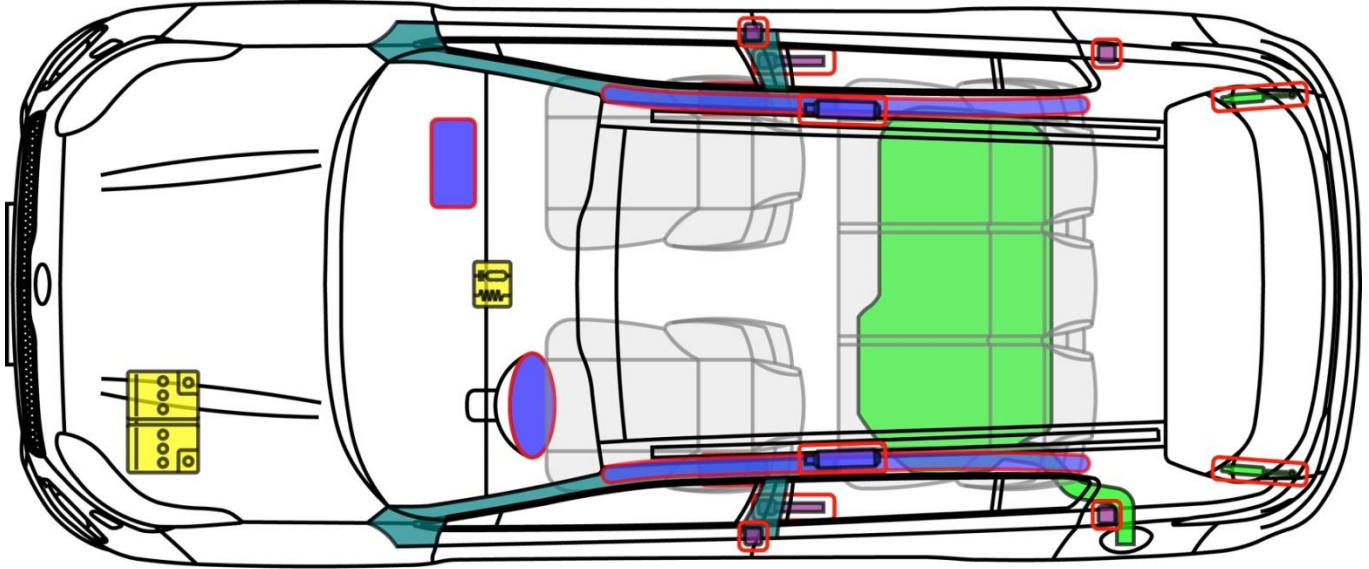

## Legende

	Airbag		Karosserieverstärkung		Steuergerät
	Gas-generator		Fußgänger-Schutzsystem		12 V Batterie
	Gurtstraffer		Gasdruckdämpfer		Kraftstoff-tank

Sportage





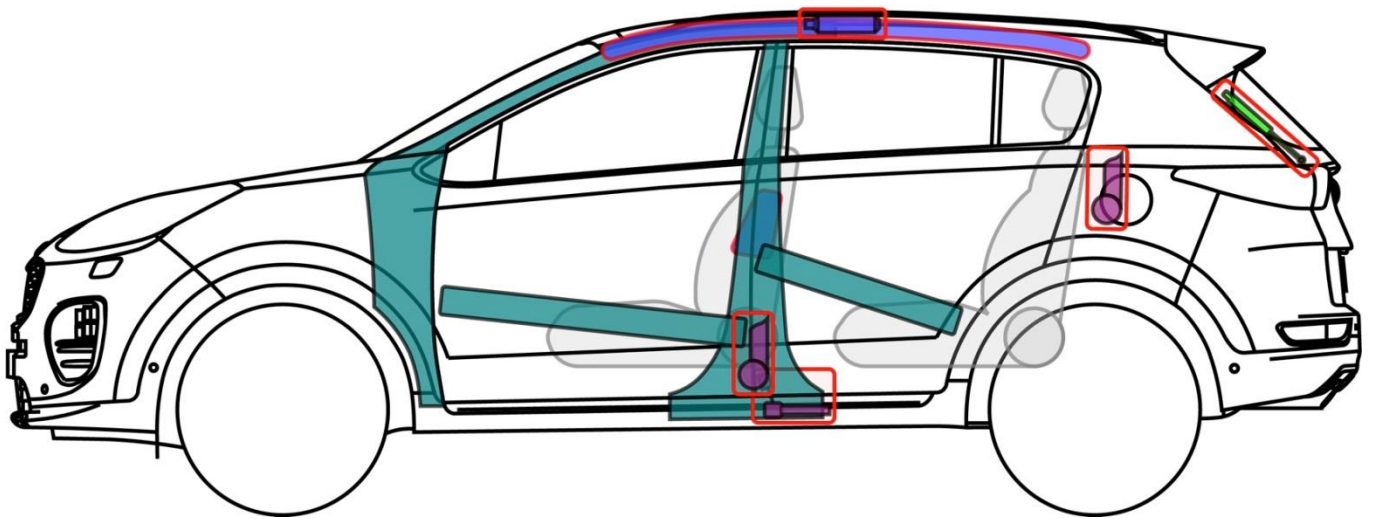
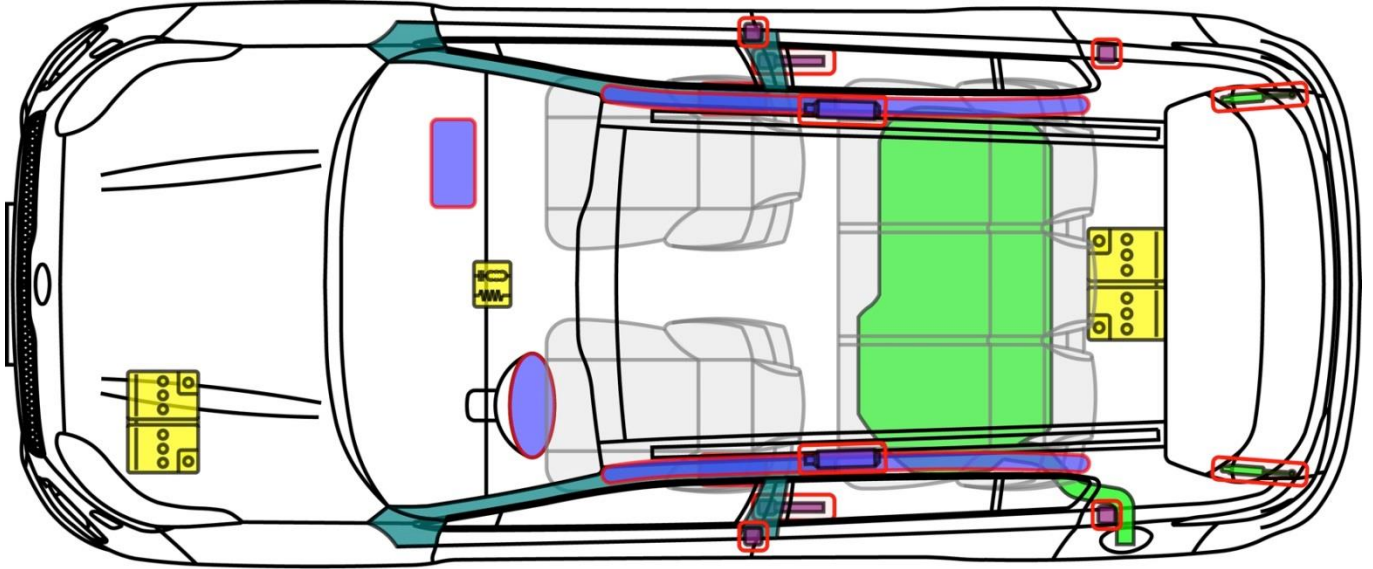

# Sportage (QL)

ab MY 2019-  
48V Mild Hybrid Batterie

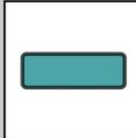

## Legende

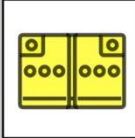
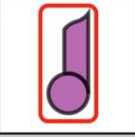
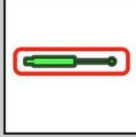
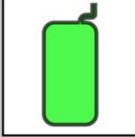
	Airbag		Karosserie- verstärkung		Steuergerät
	Gas- generator		Fußgänger- Schutz- system		12 V Batterie
	Gurt- straffer		Gasdruck- dämpfer		Kraftstoff- tank

Sportage



# Stinger (CK)

ab 2017

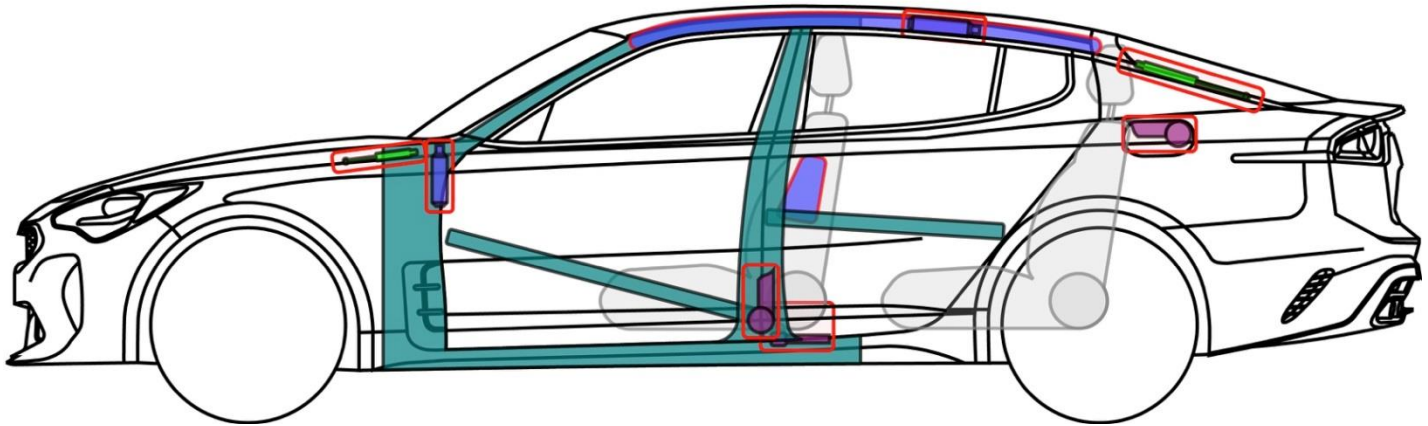
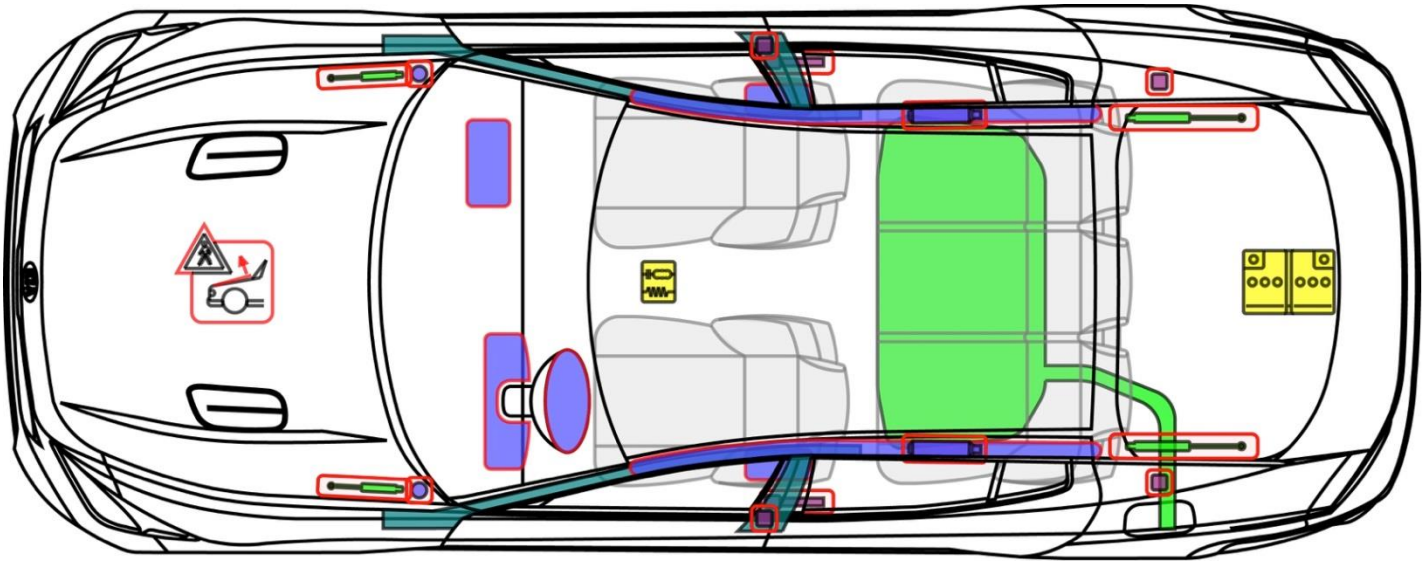

## Legende

	Airbag		Karosserieverstärkung		Steuergerät
	Gas-generator		Fußgänger-Schutzsystem		12 V Batterie
	Gurtstraffer		Gasdruckdämpfer		Kraftstofftank

Stinger



# Stonic (YB-CUV)

5-Türer, ab 2017

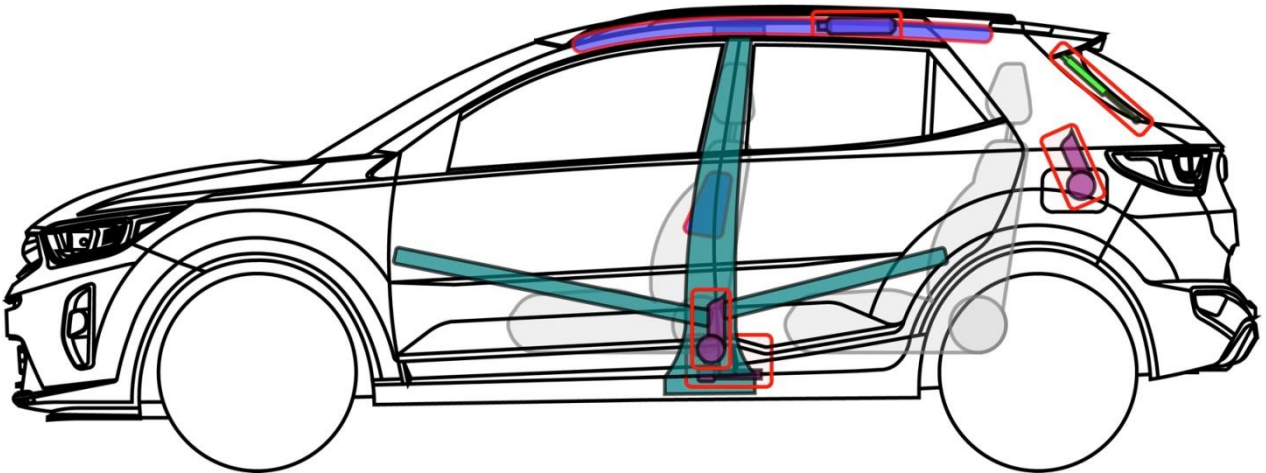
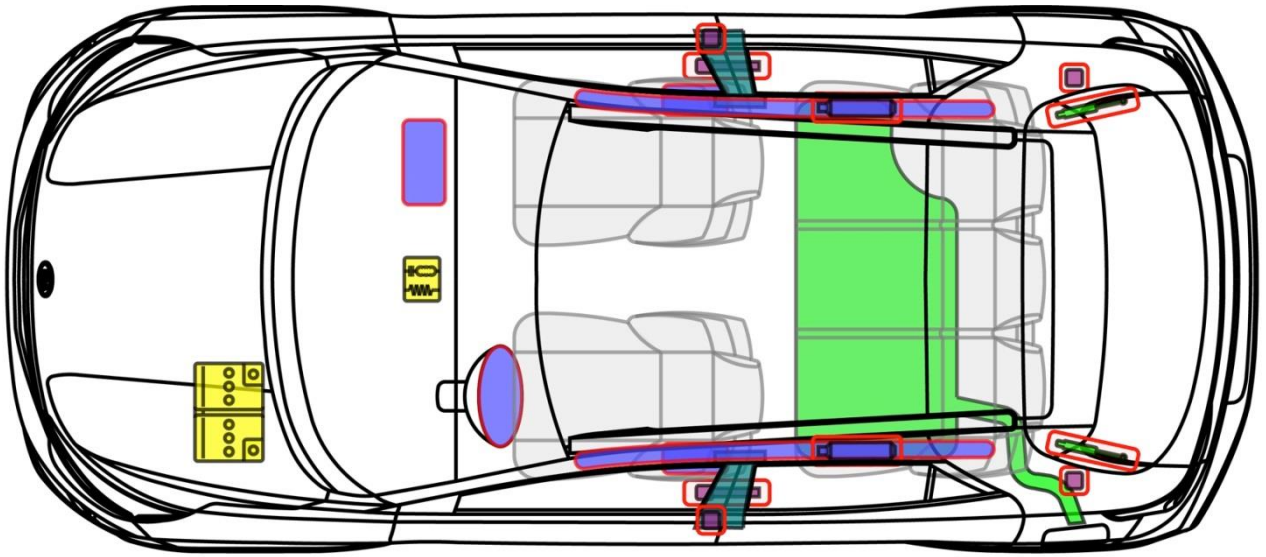

## Legende

	Airbag		Karosserie-verstärkung		Steuergerät
	Gas-generator		Fußgänger-Schutz-system		12 V Batterie
	Gurt-straffer		Gasdruck-dämpfer		Kraftstoff-tank

Stonic



# Venga (YN)

ab 2010  
inklusive Facelift

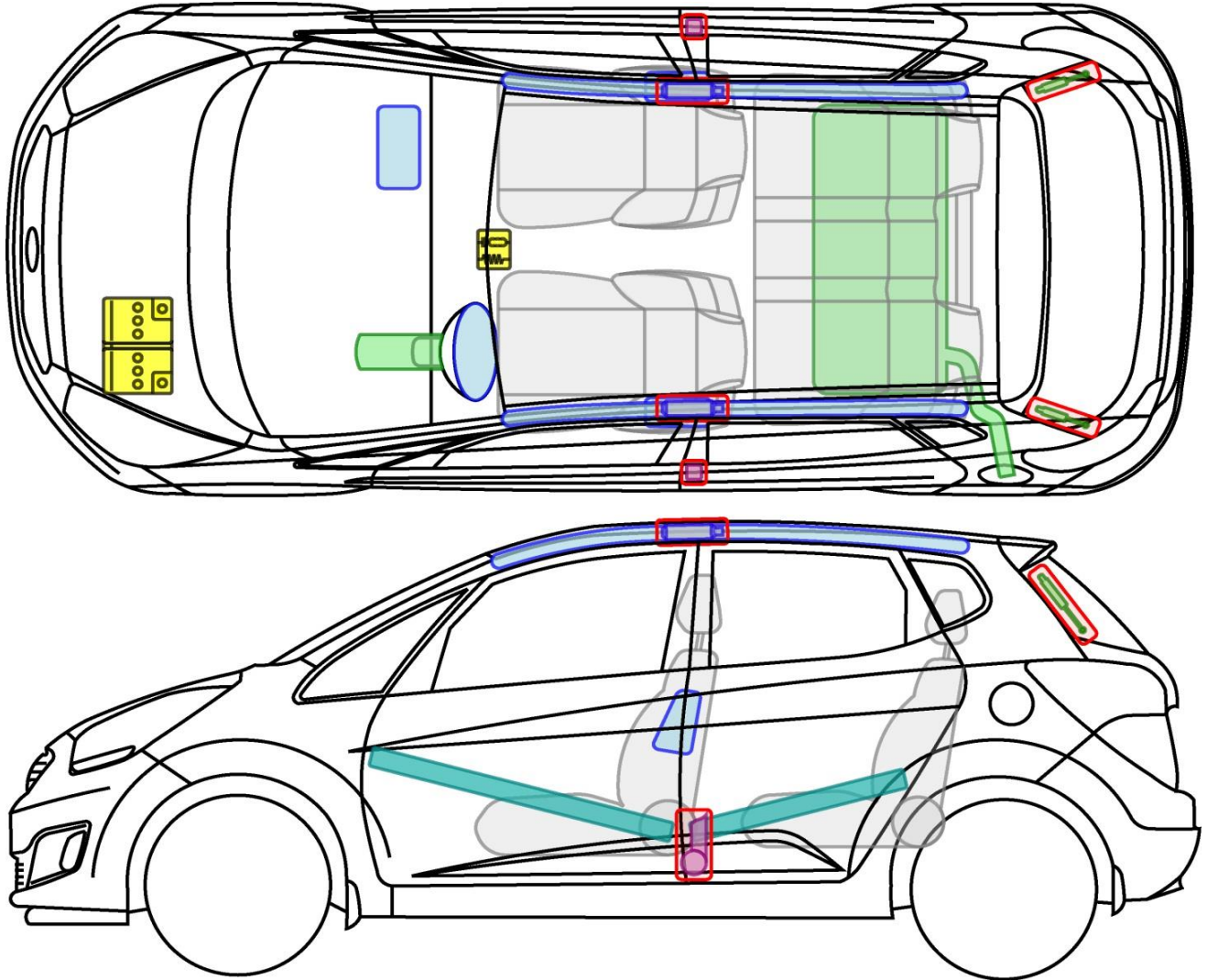

## Legende

	Airbag		Karosserie- verstärkung		Steuergerät
	Gas- generator		Überroll- schutz		Batterie
	Gurt- straffer		Gasdruck- dämpfer		Kraftstoff- tank

Venga