

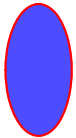













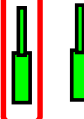

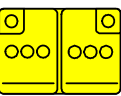

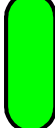

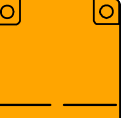

Hinweis: Es ist die maximal mögliche Ausstattung abgebildet.

	Airbag		Gasgenerator		Gurtstraffer		SRS Steuergerät		Aktives Fußgängerschutzsystem
	Automatisches Überrollschutzsystem		Gasdruckdämpfer / Vorgespannte Feder		Karosserie-Verstärkung		Sensibler Bereich		
	Niedervolt-batterie		Niedervolt-Kondensator		Treibstofftank		Gastank		Sicherheitsventil
	Hochvolt-batterie		Hochspannungskabel		Hochspannungselement das die Hochspannung abschaltet		Sicherungskasten Deaktivierung Hochvoltsystem		Hochspannungskomponente
	Niedervolt-vorrichtung zur Hochvolt-abschaltung		Hochvolt-Sicherungskasten		Kraftstoff- / Ethanol-tank		Hebepunkt / zentrale Stütze		Hochvoltkomponente

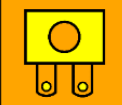
Marke	Art	Stufe	Markteinführungsjahr	Interne Referenz	Erstellungsdatum	Ausgabe	Versions-Nr.	Seite
CUPRA	Formentor	1	2021	VSC-KM70H50	15.02.2020	28.01.2021	1	1 von 4



## 1. Identifikation / Erkennungsmerkmale



Der Elektromotor ist geräuschlos. Die linke Zeigeranzeige im Kombiinstrument (Powermeter) zeigt an, ob der Elektromotor ausgeschaltet „OFF“ oder betriebsbereit „READY“ ist.

Ladedose



Orange Leitung



## 2. Immobilisierung / Stabilisierung / Anheben

### Fahrzeug immobilisieren

Taste „P“ (Parken) drücken und Feststellbremse betätigen.

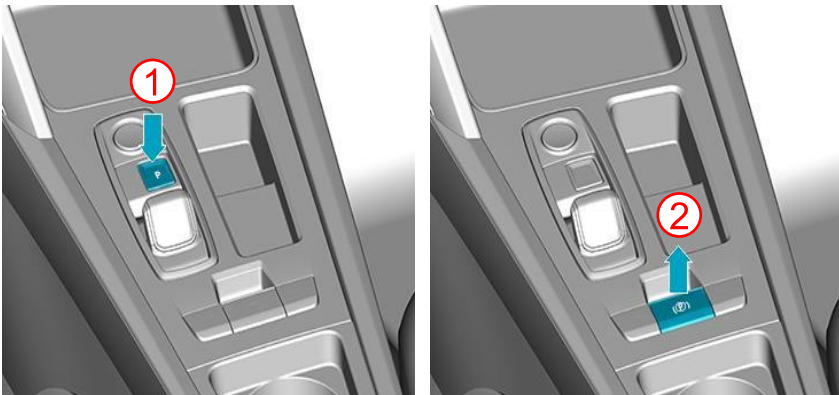

### Hebepunkte

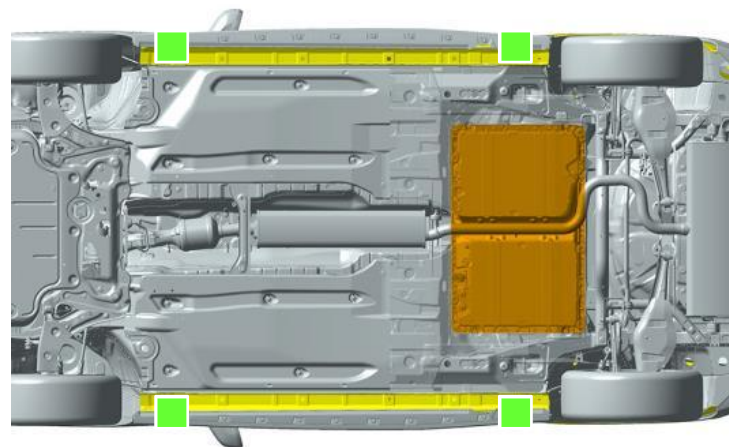

- Geeignete Hebepunkte
- Hochvolt-batterie

## 3. Kontrolle direkter Risiken / Sicherheitsregeln

### Motor ausschalten (Fahrleistungsanzeige „Off“)



START-STOPP-Taste drücken ohne das Bremspedal zu betätigen

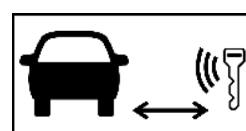

Anstelle eines Funkschlüssels kann auch eine Code-Karte oder eine Anwendung für Smartphone verwendet werden.

### Hochvoltsystem deaktivieren

Möglichkeit 1: Deaktivierung vom Motorraum aus.

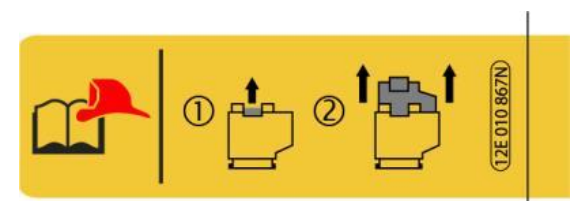
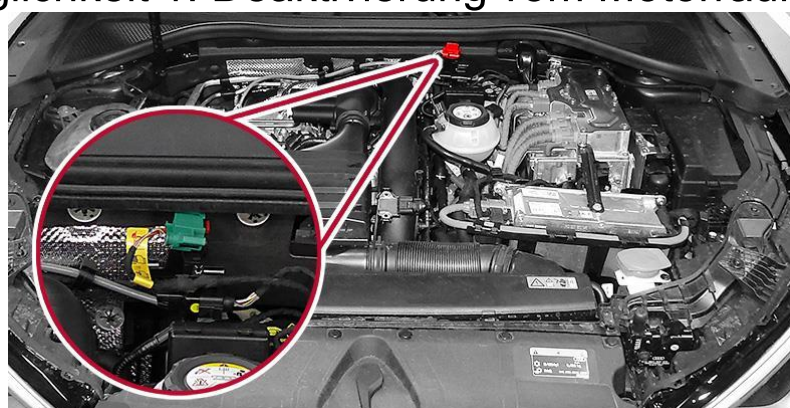

Marke	Art	Stufe	Markteinführungsjahr	Interne Referenz	Erstellungsdatum	Ausgabe	Versions-Nr.	Seite
CUPRA	Formentor	1	2021	VSC-KM70H50	15.02.2020	28.01.2021	1	2 von 4



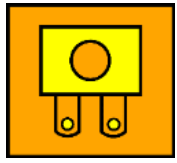

**Möglichkeit 2: Vom Fahrgastraum aus sichern**



Linkslenker (neben der Lenksäule)

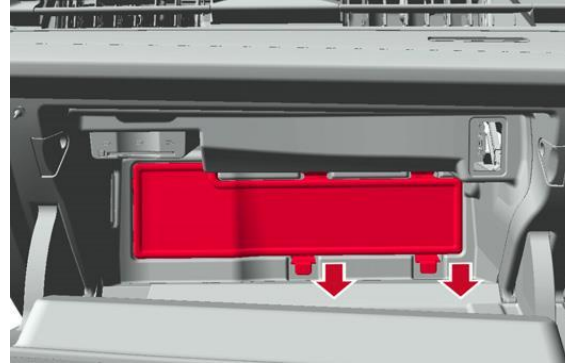

Rechtslenker (im Handschuhfach)

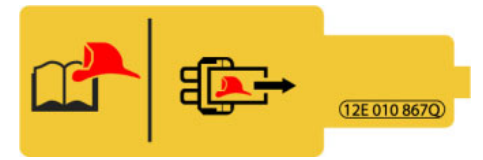

Hochvoltkomponenten und Hochvoltbatterie nicht berühren, trennen oder öffnen!  
Geeignete Schutzausrüstung tragen!

Bei Unfällen mit Airbagauslösung wird das Hochvoltssystem automatisch deaktiviert.  
Das Hochvoltssystem ist nach der Deaktivierung innerhalb von ca. 20 Sekunden spannungsfrei.

**12V-Batterie abschalten**

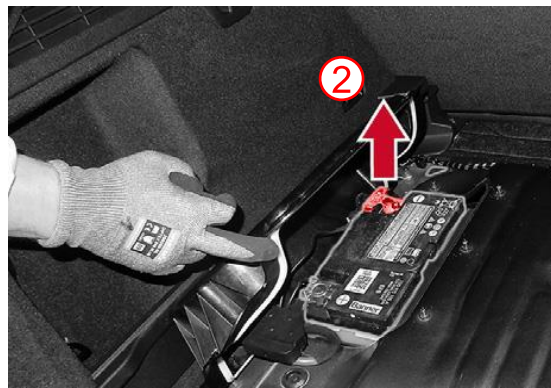
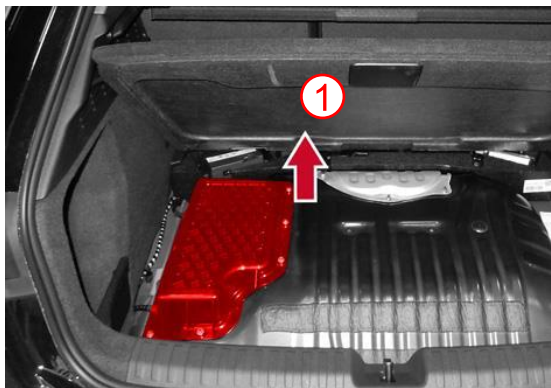
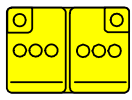

**Von der Ladestation trennen (Notentriegelung)**

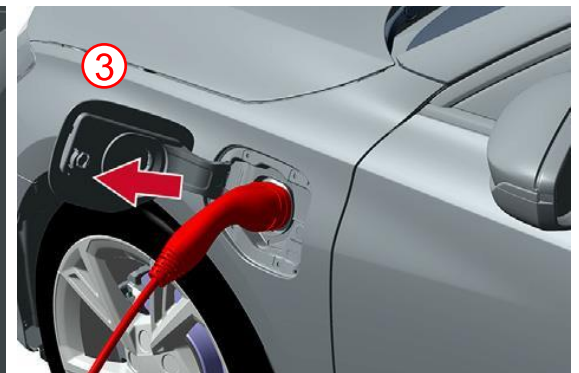
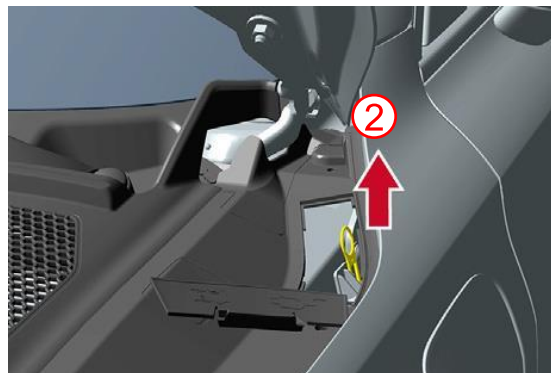
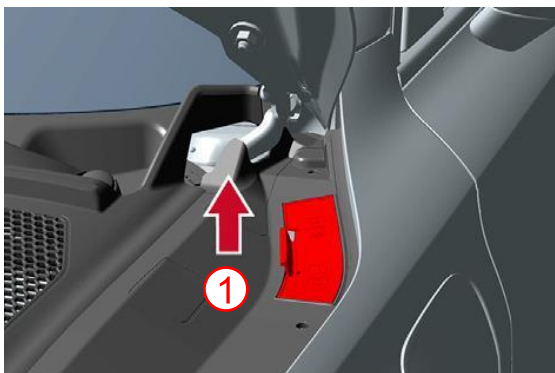

**4. Zugang zu den Fahrzeuginsassen**

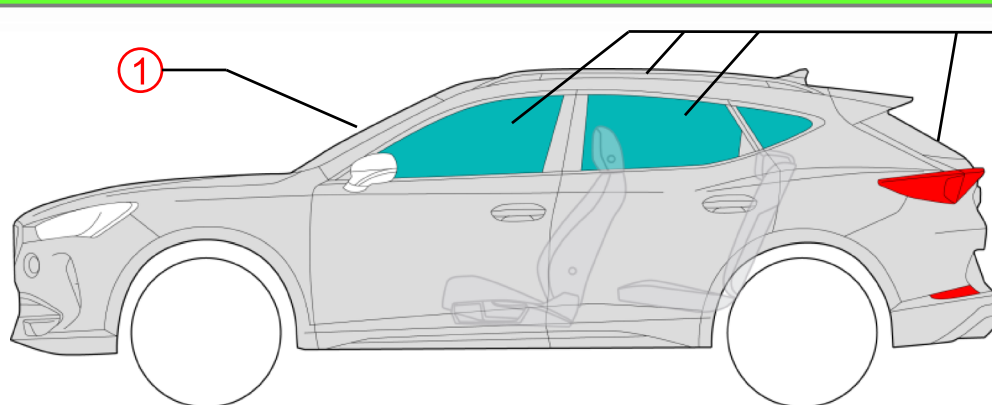

- Verglasung:**
- ① Verbundsicherheitsglas
  - ② Einscheiben-Sicherheitsglas

**5. Energiespeicher / Flüssigkeiten / Gase / Feststoffe**

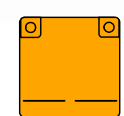

LI ION



400 V

Marke	Art	Stufe	Markteinführungsjahr	Interne Referenz	Erstellungsdatum	Ausgabe	Versions-Nr.	Seite
CUPRA	Formentor	1	2021	VSC-KM70H50	15.02.2020	28.01.2021	1	3 von 4



					40 L
---	---	---	---	--	------

					12 V
---	---	---	---	--	------

 Wenn Kühlmittel aus dem Kühlsystem austritt, besteht die Gefahr einer chemischen Reaktion in der Hochvoltbatterie. Temperatur der Hochvoltbatterie prüfen!



### 6. Im Brandfall

				
--	---	---	---	---



 Lithium-Ionen-Batterien können durch Beschädigung oder unsachgemäße Handhabung sowohl spontan wie auch zeitverzögert in Brand geraten. Außerdem können sie sich nach Löschen des Brands erneut selbst entzünden. Geeignete persönliche Schutzausrüstung tragen!





### 7. Bei Eintauchen

Nach der Bergung des Fahrzeugs aus dem Wasser, Hochvoltsystem deaktivieren (siehe Kapitel 3) und das Wasser ablaufen lassen. Geeignete Schutzausrüstung tragen!















### 8. Abschleppen / Transport / Aufbewahrung

✓		<p>Fahrzeug nicht auf der Antriebsachse abschleppen. Hochvoltsystem deaktivieren (siehe Kapitel 3). Fahrzeug in sicher Entfernung von Gebäuden und anderen Fahrzeugen abstellen (min. 5 m) (Quarantänefläche).</p>
✗		

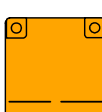
 Lithium-Ionen-Batterien können sich selbst entzünden. Lithium-Ionen-Batterien können sich nach der Brandbekämpfung erneut entzünden.

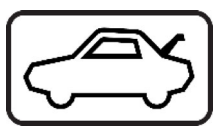

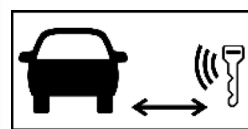
### 10. Bedeutung der verwendeten Piktogramme

							
Entzündbar	Explosiv	Korrosiv	stark Gesundheits- schädlich	Umweltgefährlich	Plug-in- Hybridfahrzeug mit Flüssigkraftstoff	Warnung Hochvolt	Gefahr
	LI ION 						
Mit Wasser löschen	Lithium-Ionen- Batterie	Gefährliche Spannung	Frontklappe	Kofferraum	IR- Wärmebildkamera benutzen	Intelligenten Schlüssel entfernen	Benzin- kraftstoff

Marke	Art	Stufe	Markteinführungsjahr	Interne Referenz	Erstellungsdatum	Ausgabe	Versions-Nr.	Seite
CUPRA	Formentor	1	2021	VSC-KM70H50	15.02.2020	28.01.2021	1	4 von 4