

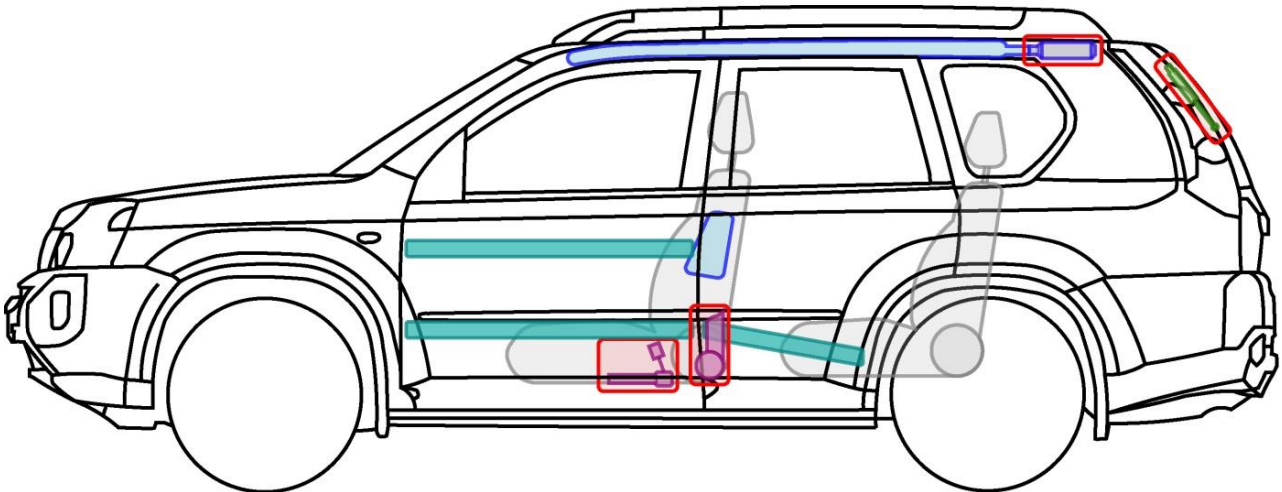

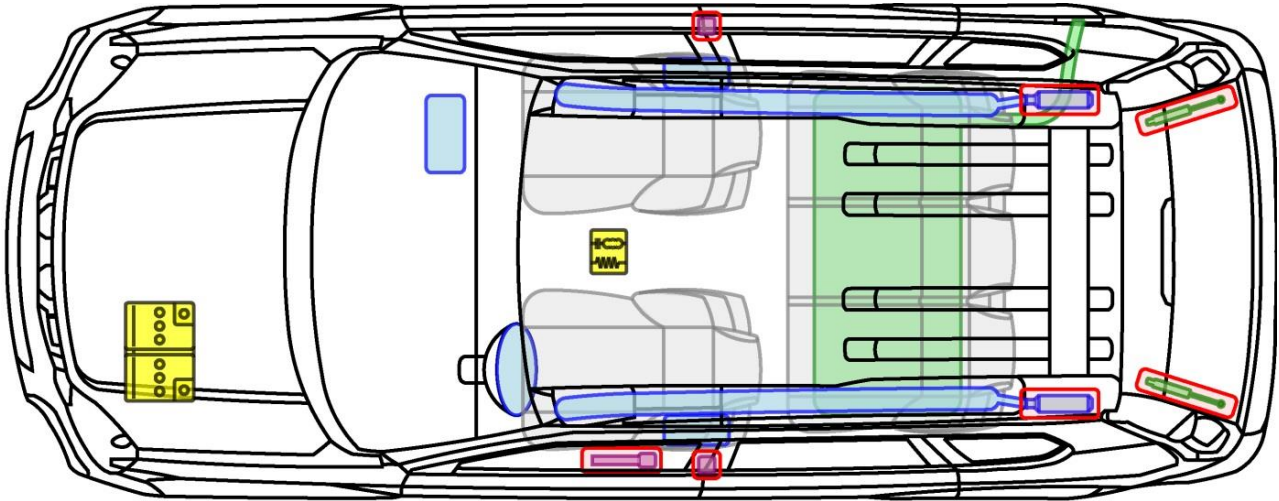

X-TRAIL

Typ: T31, 2007-2014

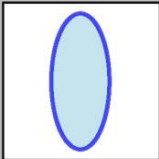

Legende

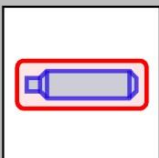
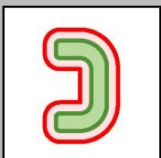
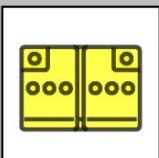
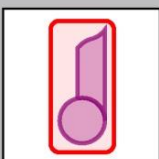
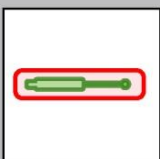
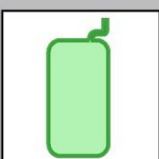
	Airbag		Karosserie- verstärkung		Steuergerät
	Gas- generator		Überroll- schutz		Batterie
	Gurt- straffer		Gasdruck- dämpfer		Kraftstoff- tank

