

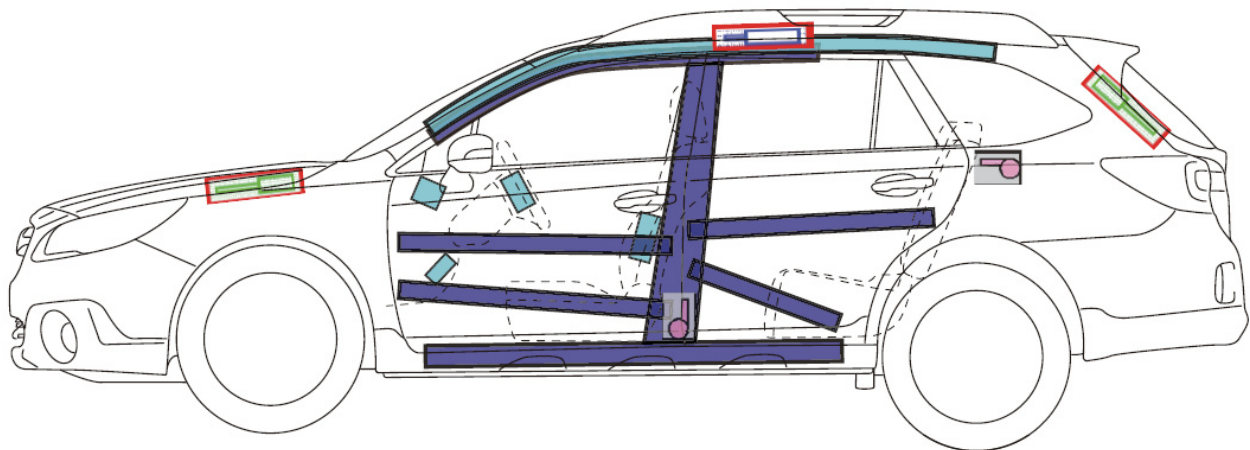

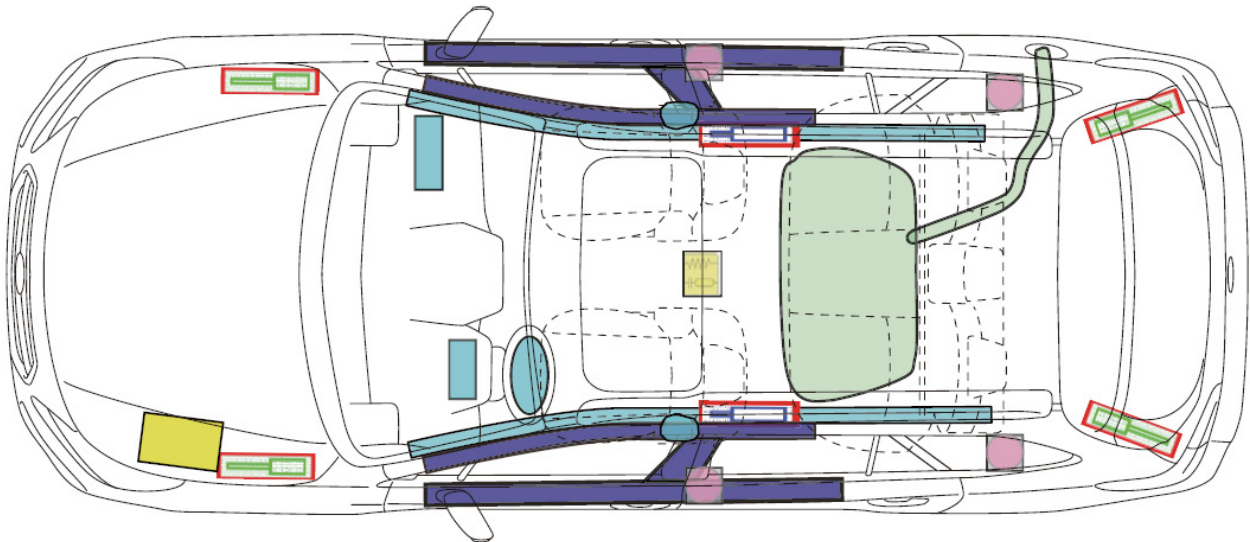

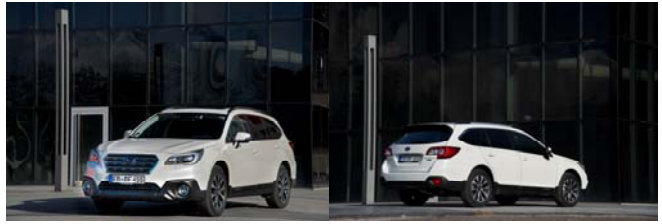



SUBARU: Outback 2,5l & 2,0D  
 Typ: BSD/BS9  
 Karosserievariante ab MJ 2015



Airbag Modul		Karosserieverstärkung		Airbag Kontrollmodul	
Fensterairbag Gasgenerator				Batterie	
Gurtstraffer		Hauben & Heckklappendämpfer		Kraftstofftank	

### Warnhinweise

Nach dem Abklemmen der Batterie 30 Sekunden warten.