

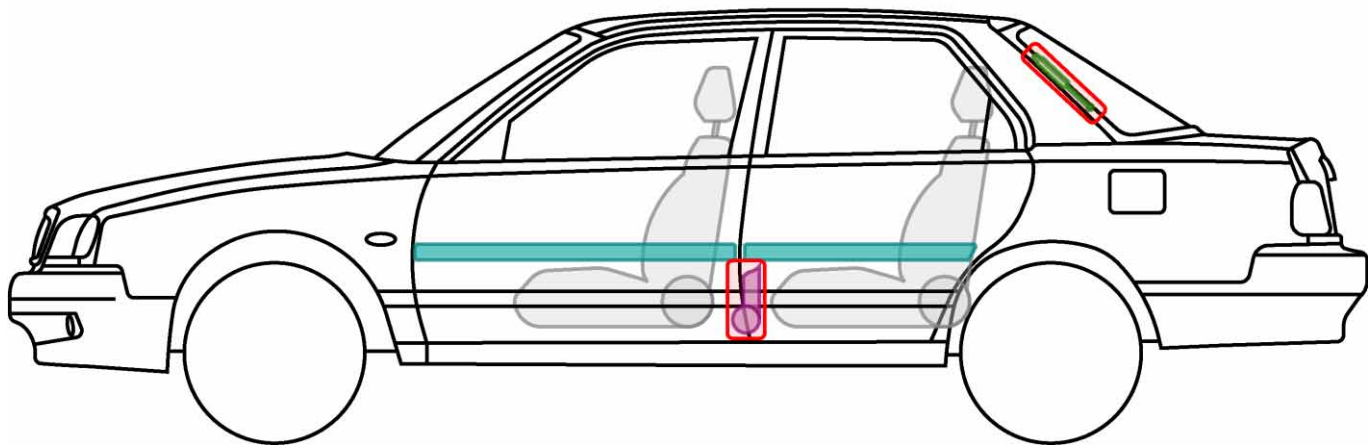

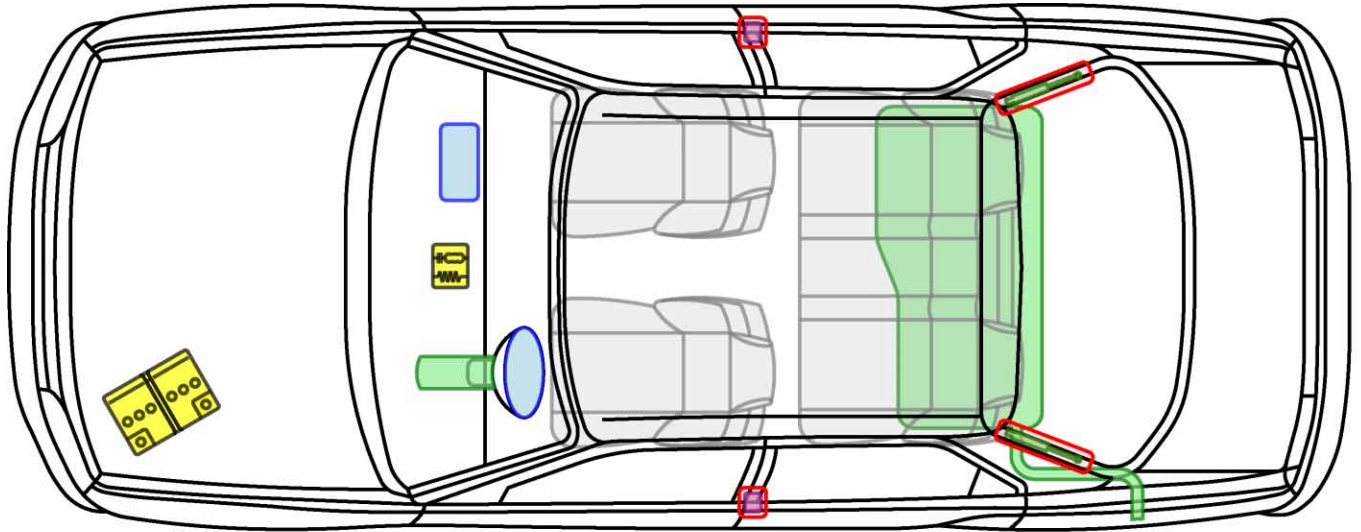









DAIHATSU

Die perfekte Grösse.

APPLAUSE (A101) 1998-2001

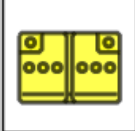

Legende

| | | | | | |
|---|-------------------|---|----------------------------|--|---------------------|
|  | Airbag |  | Karosserie- verstärkung |  | Steuergerät |
|  | Gas- generator |  | Überroll- schutz |  | Batterie |
|  | Gurt- straffer |  | Gasdruck- dämpfer |  | Kraftstoff- tank |

Applause









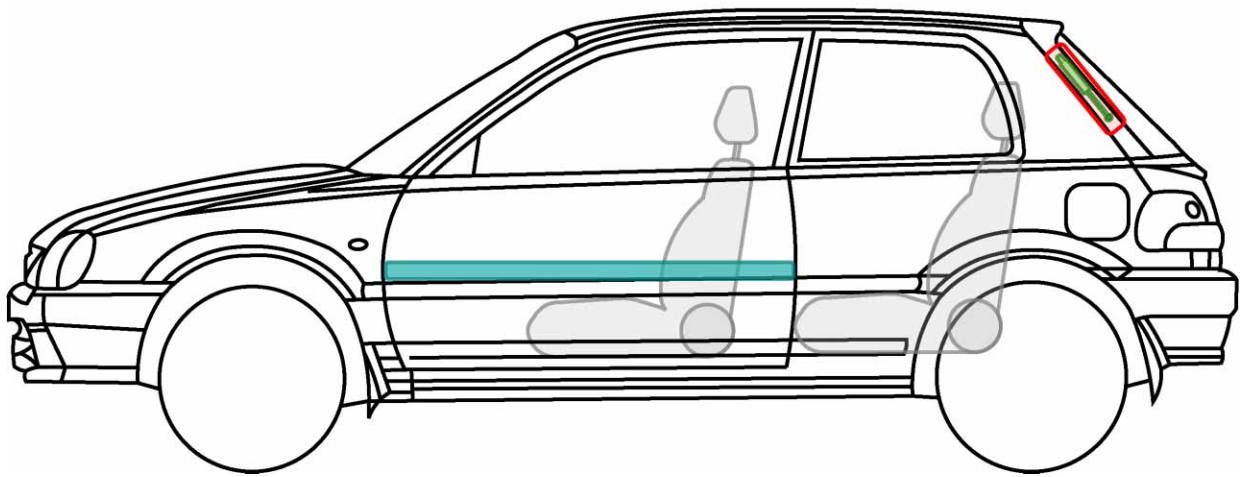
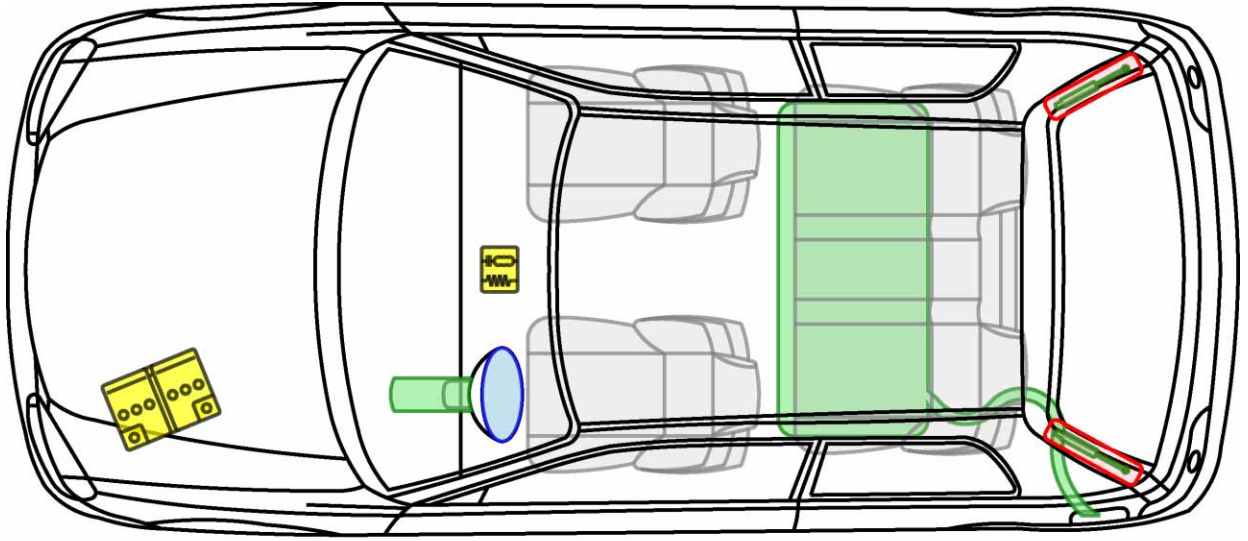

DAIHATSU

Die perfekte Grösse.

CHARADE (G2) 1996-2001

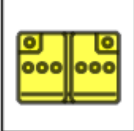

Legende

| | | | | | |
|---|-------------------|---|----------------------------|--|---------------------|
|  | Airbag |  | Karosserie- verstärkung |  | Steuergerät |
|  | Gas- generator |  | Überroll- schutz |  | Batterie |
|  | Gurt- straffer |  | Gasdruck- dämpfer |  | Kraftstoff- tank |

Charade



DAIHATSU

Die perfekte Grösse.

CHARADE (G2) 1996-2001

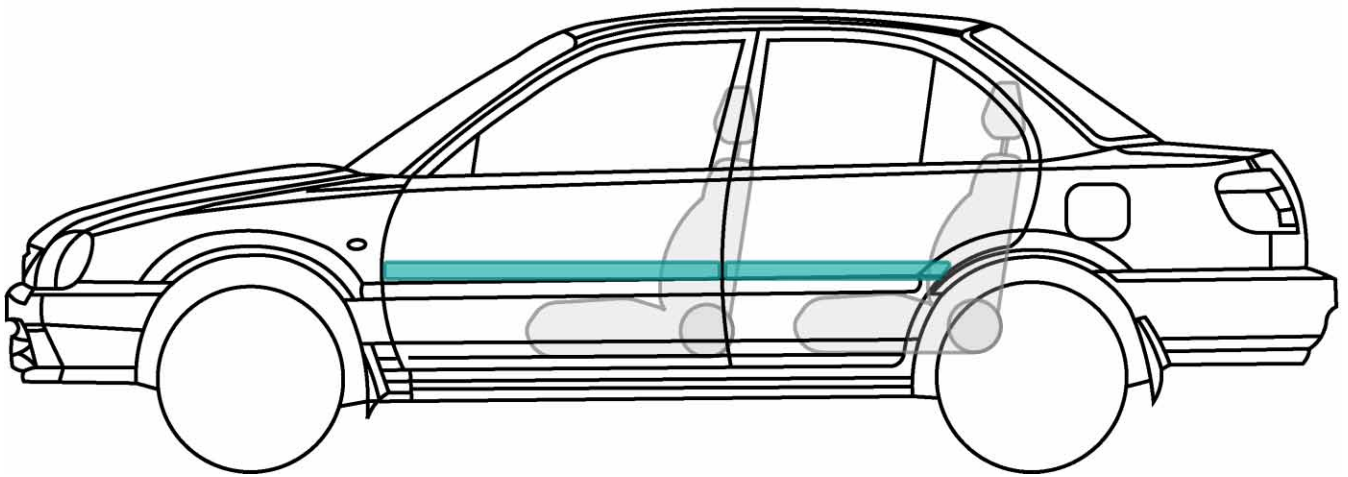
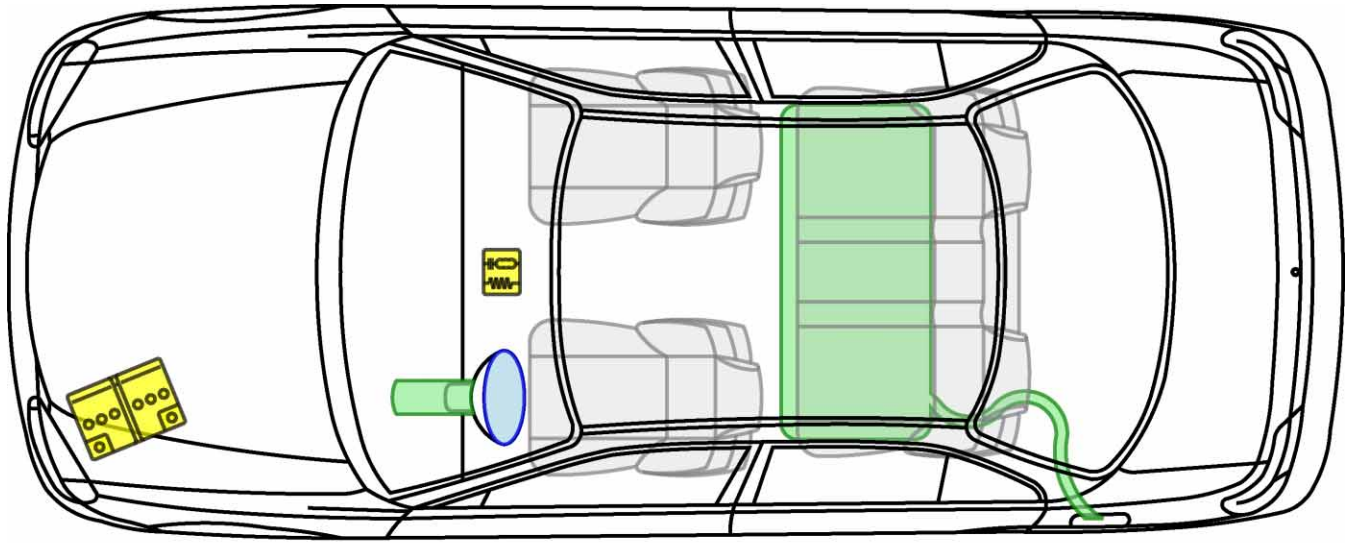

Legende

| | | | | | |
|--|---------------|--|------------------------|--|-----------------|
| | Airbag | | Karosserie-verstärkung | | Steuergerät |
| | Gas-generator | | Überroll-schutz | | Batterie |
| | Gurt-straffer | | Gasdruck-dämpfer | | Kraftstoff-tank |

Charade









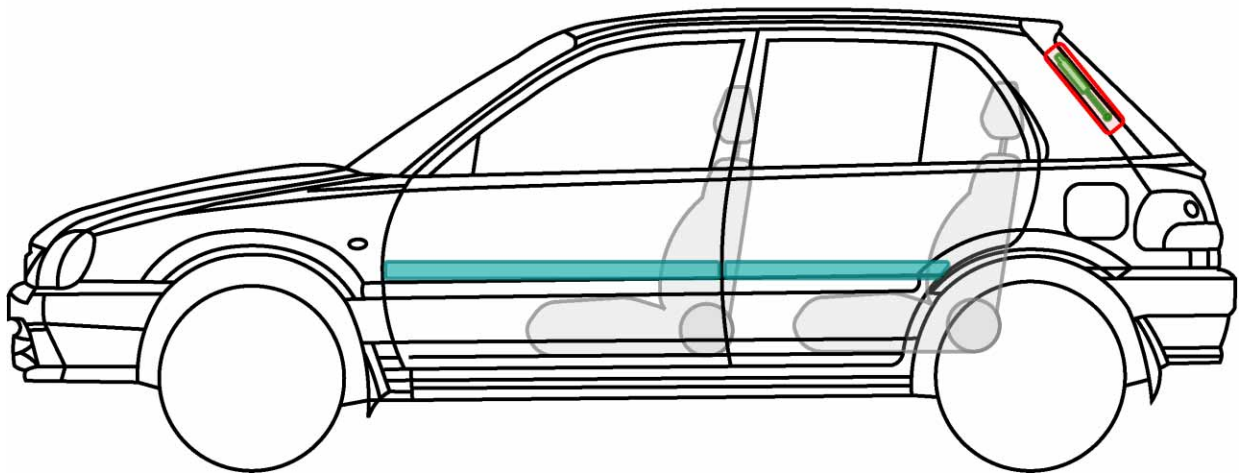
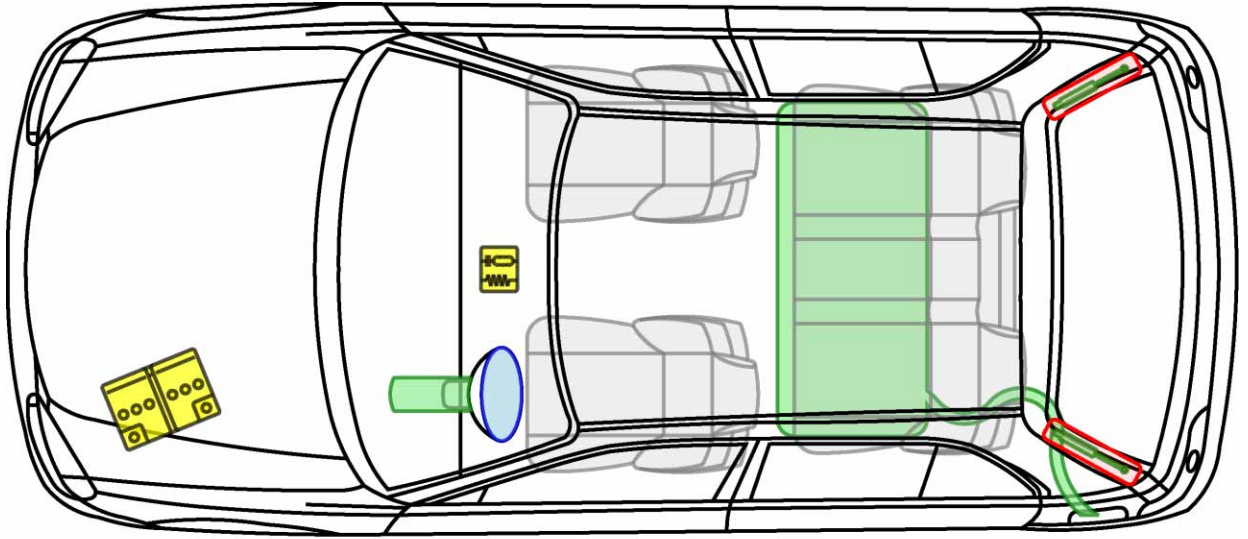

DAIHATSU

Die perfekte Grösse.

CHARADE (G2) 1996-2001

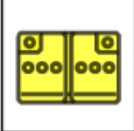

Legende

| | | | | | |
|---|-------------------|---|----------------------------|--|---------------------|
|  | Airbag |  | Karosserie- verstärkung |  | Steuergerät |
|  | Gas- generator |  | Überroll- schutz |  | Batterie |
|  | Gurt- straffer |  | Gasdruck- dämpfer |  | Kraftstoff- tank |

Charade









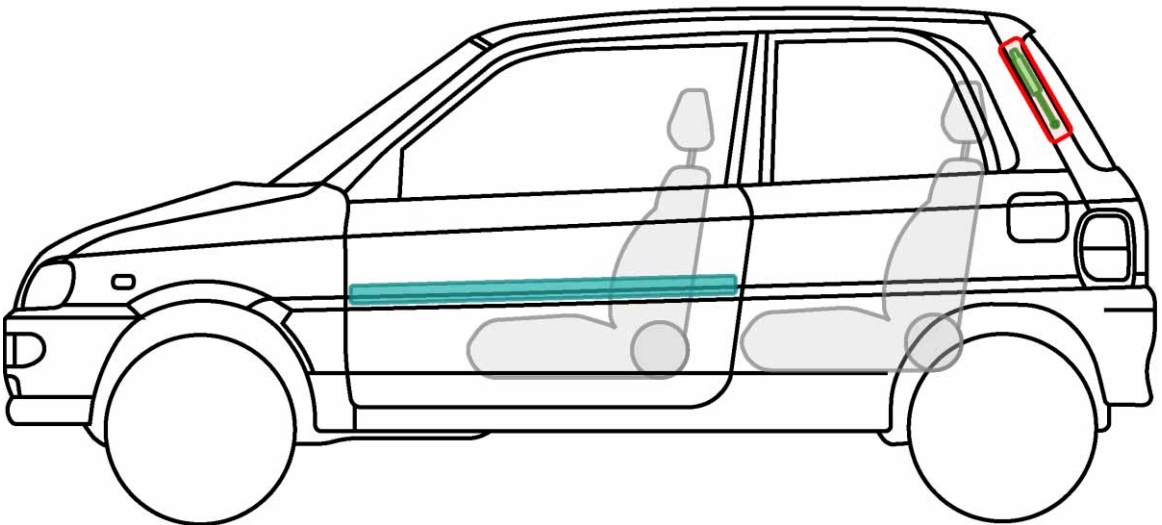
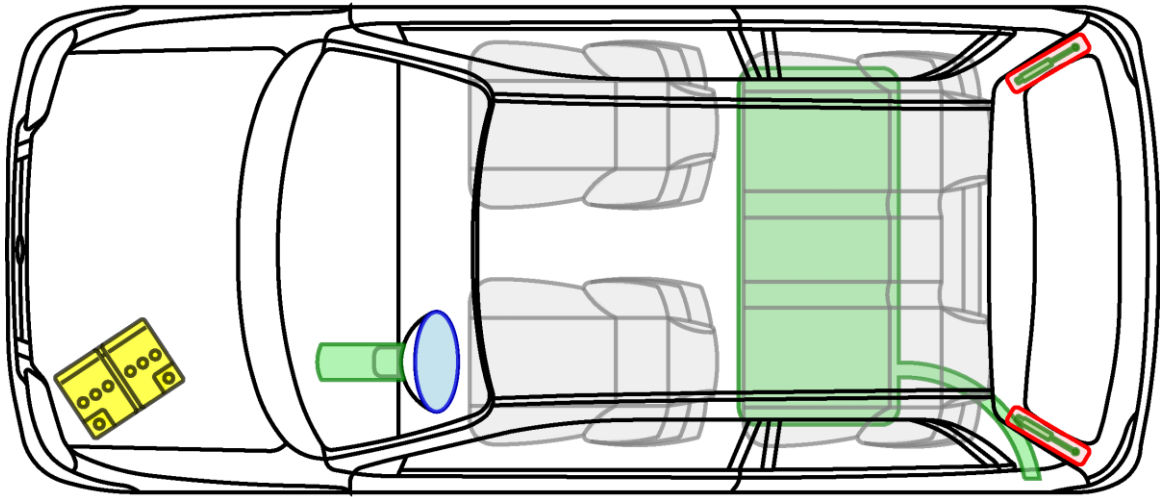

DAIHATSU

Die perfekte Grösse.

CUORE (L501) 1995-1998

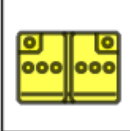

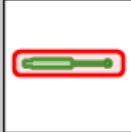
Legende

| | | | | | |
|---|-------------------|---|----------------------------|--|---------------------|
|  | Airbag |  | Karosserie- verstärkung |  | Steuergerät |
|  | Gas- generator |  | Überroll- schutz |  | Batterie |
|  | Gurt- straffer |  | Gasdruck- dämpfer |  | Kraftstoff- tank |

Cuore



DAIHATSU

Die perfekte Grösse.

CUORE (L501) 1995-1998

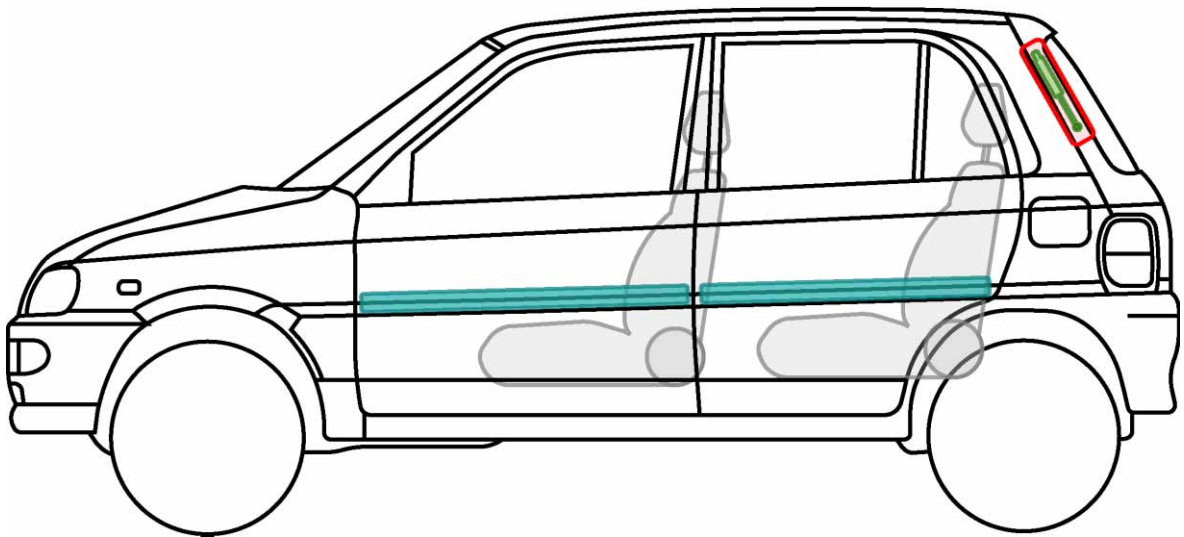
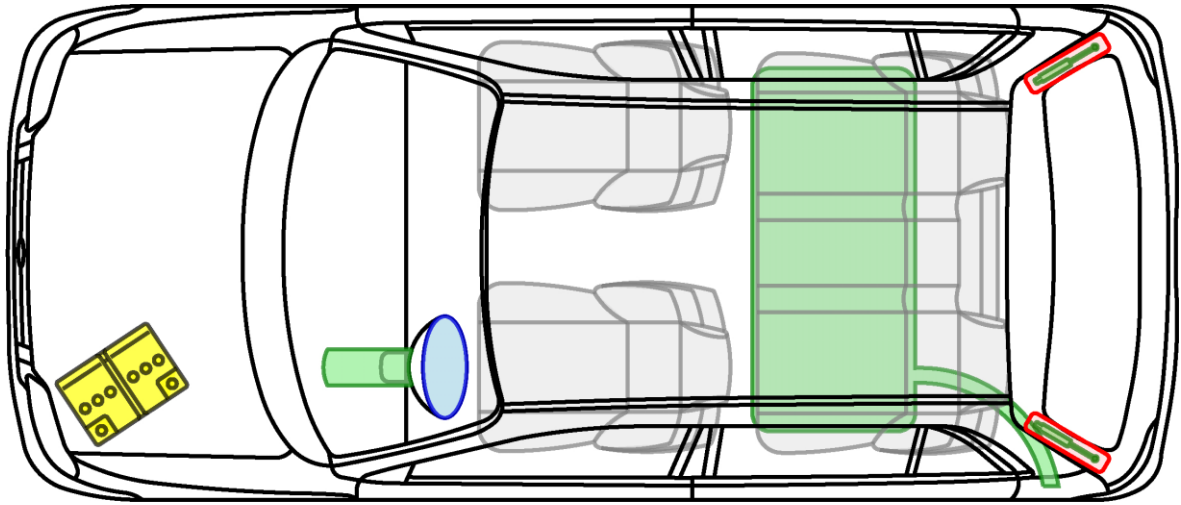

Legende

| | | | | | |
|--|---------------|--|------------------------|--|-----------------|
| | Airbag | | Karosserie-verstärkung | | Steuergerät |
| | Gas-generator | | Überroll-schutz | | Batterie |
| | Gurt-straffer | | Gasdruck-dämpfer | | Kraftstoff-tank |

Cuore



DAIHATSU

Die perfekte Grösse.

CUORE (L7) 1998-2003

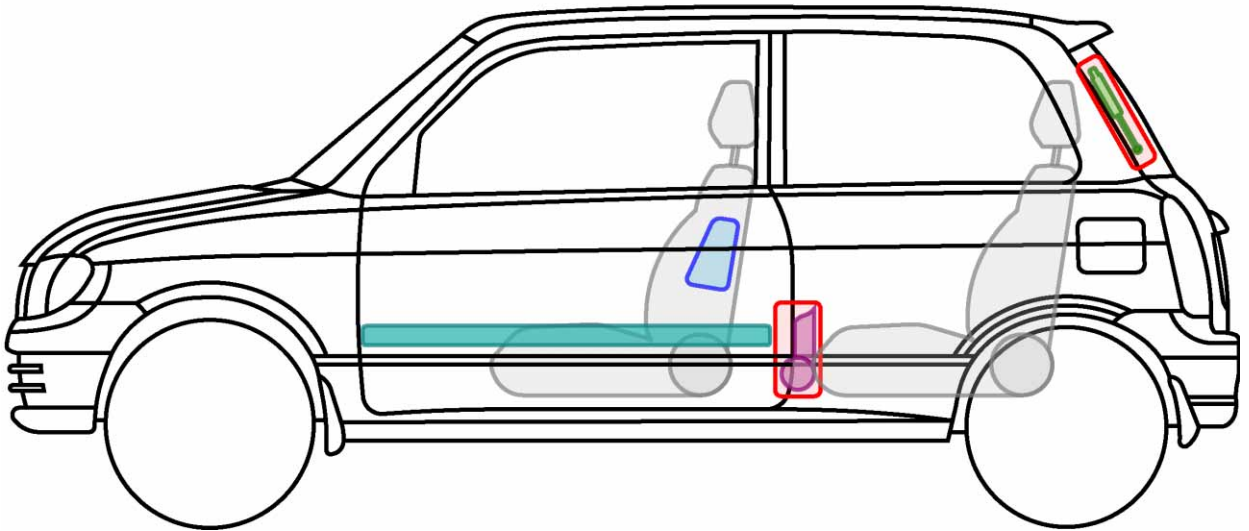
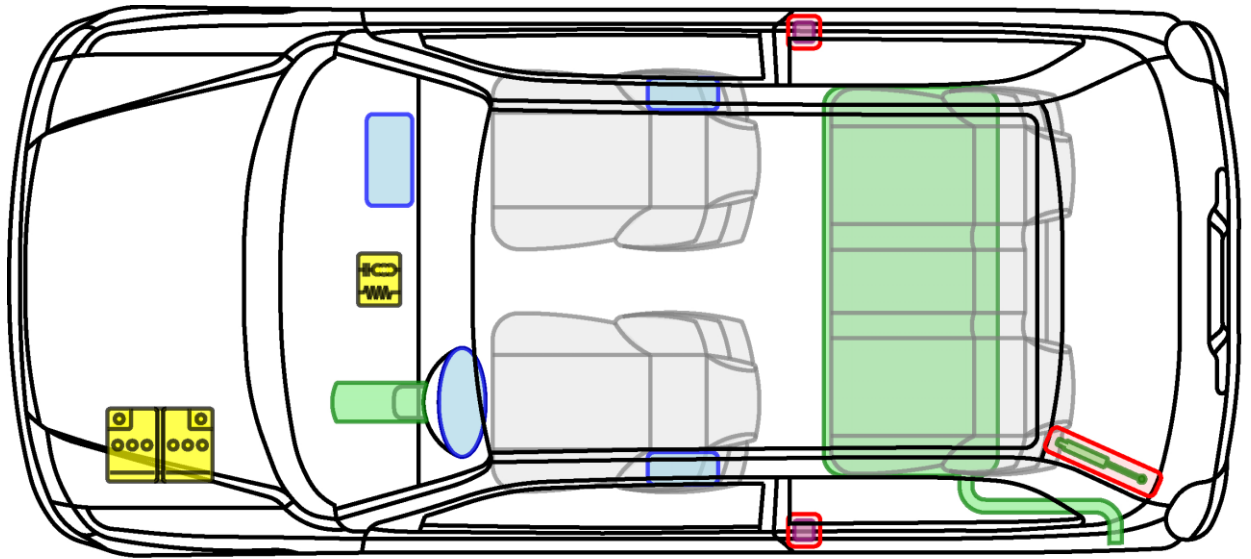

Legende

| | | | | | |
|--|-------------------|--|----------------------------|--|---------------------|
| | Airbag | | Karosserie- verstärkung | | Steuergerät |
| | Gas- generator | | Überroll- schutz | | Batterie |
| | Gurt- straffer | | Gasdruck- dämpfer | | Kraftstoff- tank |

Cuore



DAIHATSU

Die perfekte Grösse.

CUORE (L7) 1998-2003

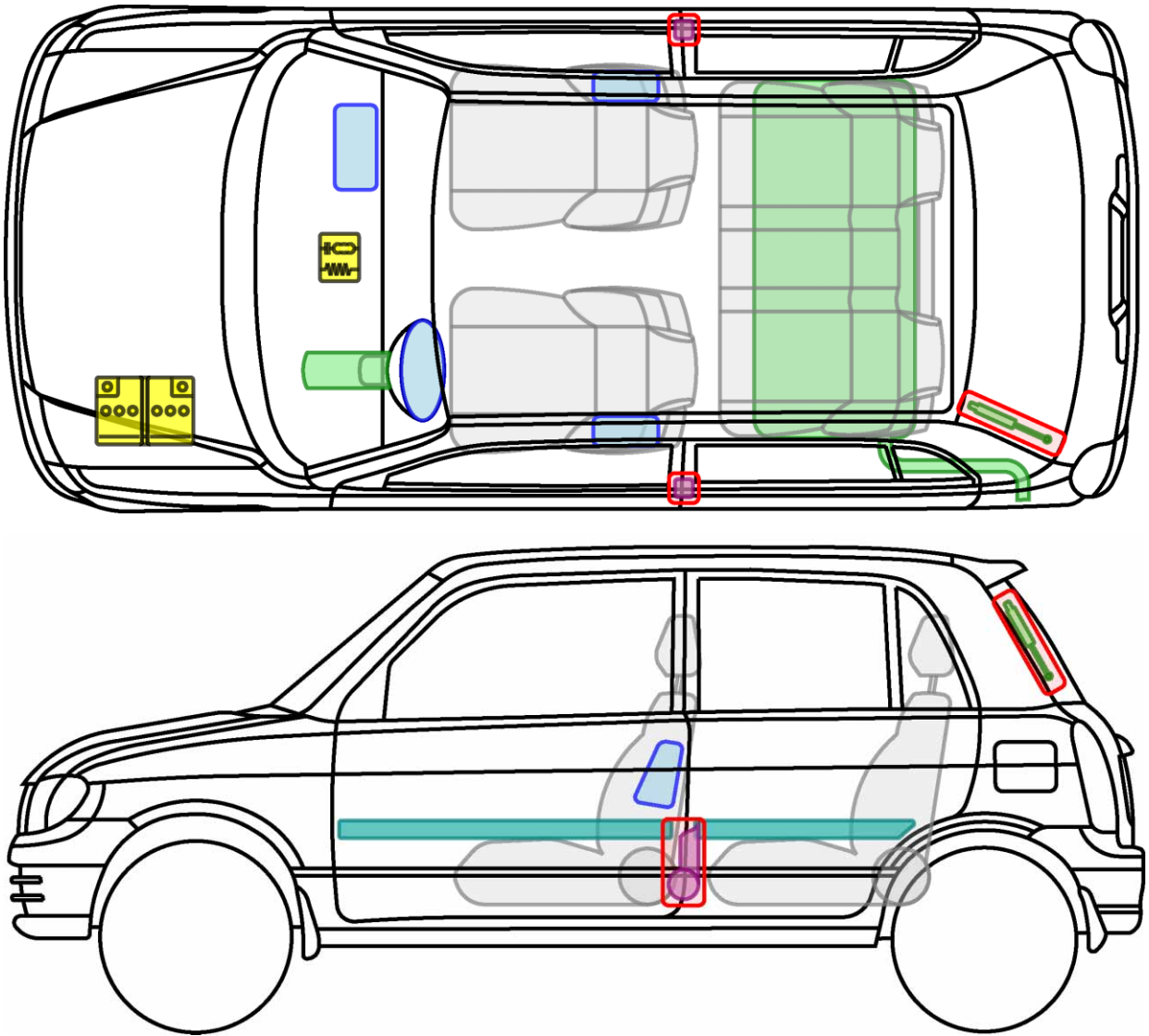

Legende

| | | | | | |
|--|-------------------|--|----------------------------|--|---------------------|
| | Airbag | | Karosserie- verstärkung | | Steuergerät |
| | Gas- generator | | Überroll- schutz | | Batterie |
| | Gurt- straffer | | Gasdruck- dämpfer | | Kraftstoff- tank |

Cuore







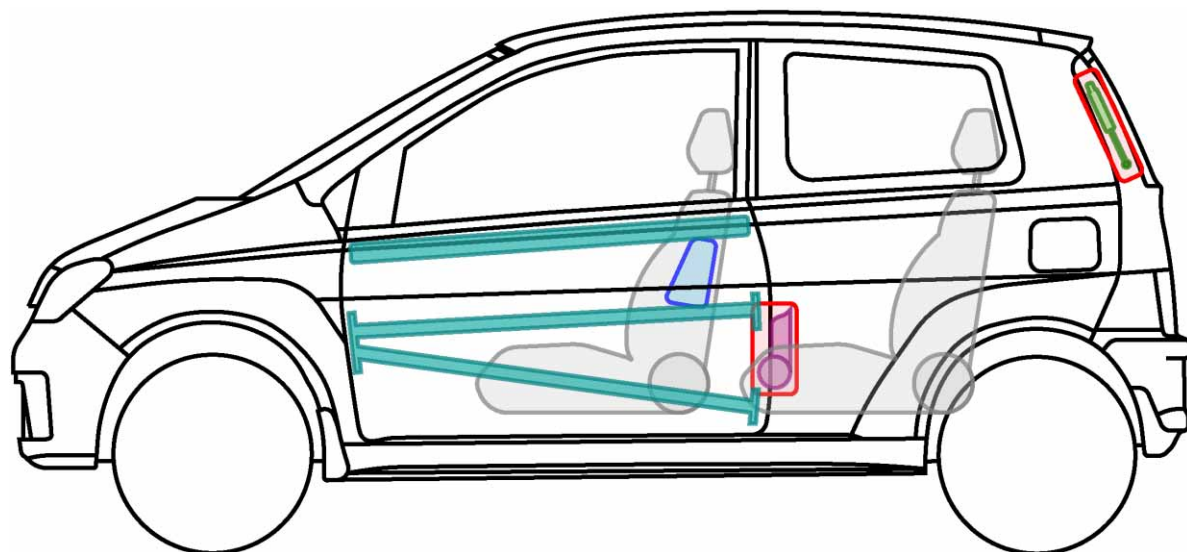
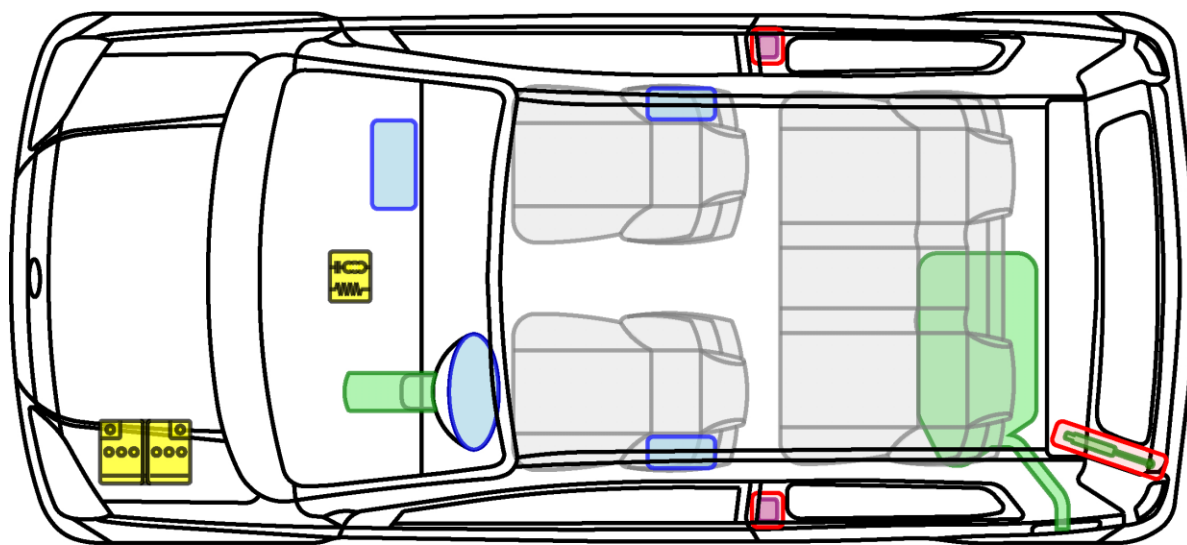

DAIHATSU

Die perfekte Grösse.

CUORE (L251) 2003-2006

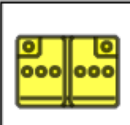
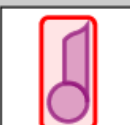

Legende

| | | | | | |
|---|-------------------|---|----------------------------|--|---------------------|
|  | Airbag |  | Karosserie- verstärkung |  | Steuergerät |
|  | Gas- generator |  | Überroll- schutz |  | Batterie |
|  | Gurt- straffer |  | Gasdruck- dämpfer |  | Kraftstoff- tank |

Cuore









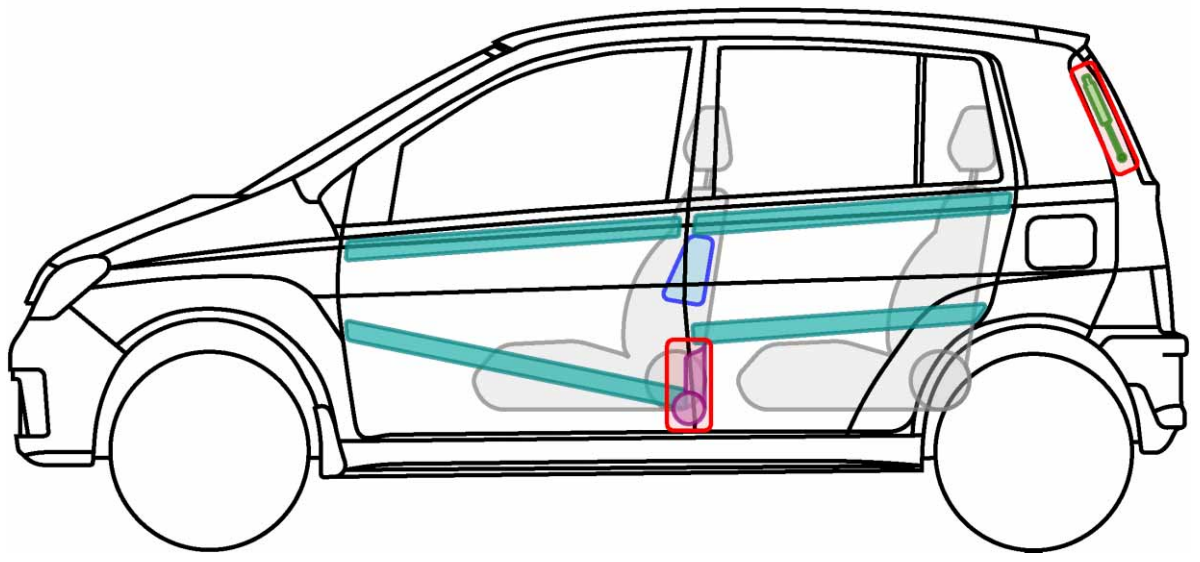
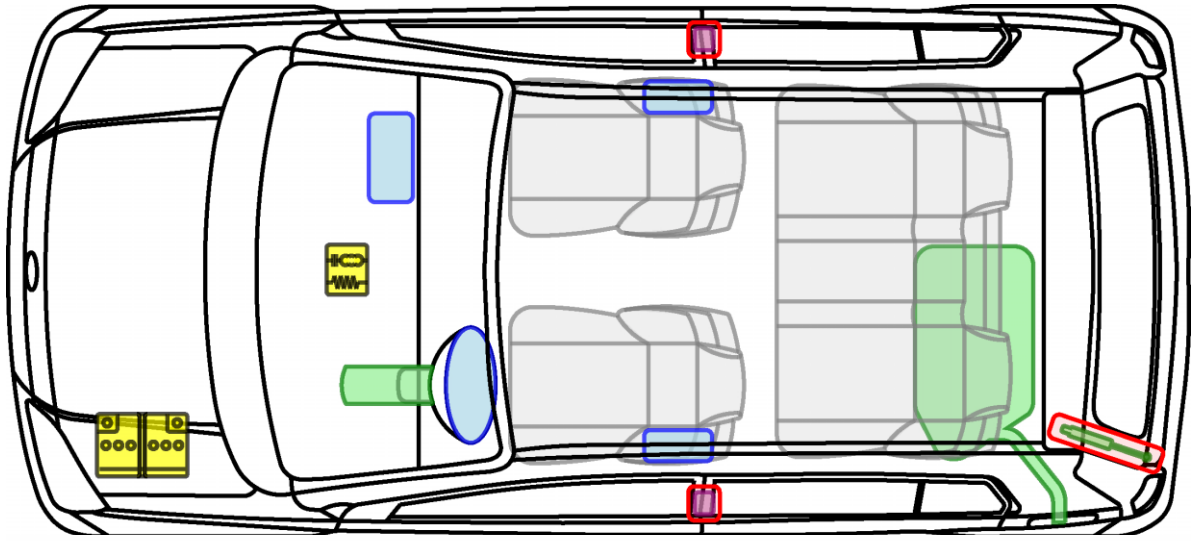

DAIHATSU

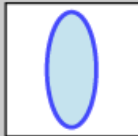
Die perfekte Grösse.

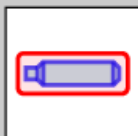
CUORE (L251) 2003-2006

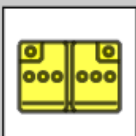

Legende

| | | | | | |
|---|---------------|---|------------------------|--|-----------------|
|  | Airbag |  | Karosserie-verstärkung |  | Steuergerät |
|  | Gas-generator |  | Überroll-schutz |  | Batterie |
|  | Gurt-straffer |  | Gasdruck-dämpfer |  | Kraftstoff-tank |

Cuore







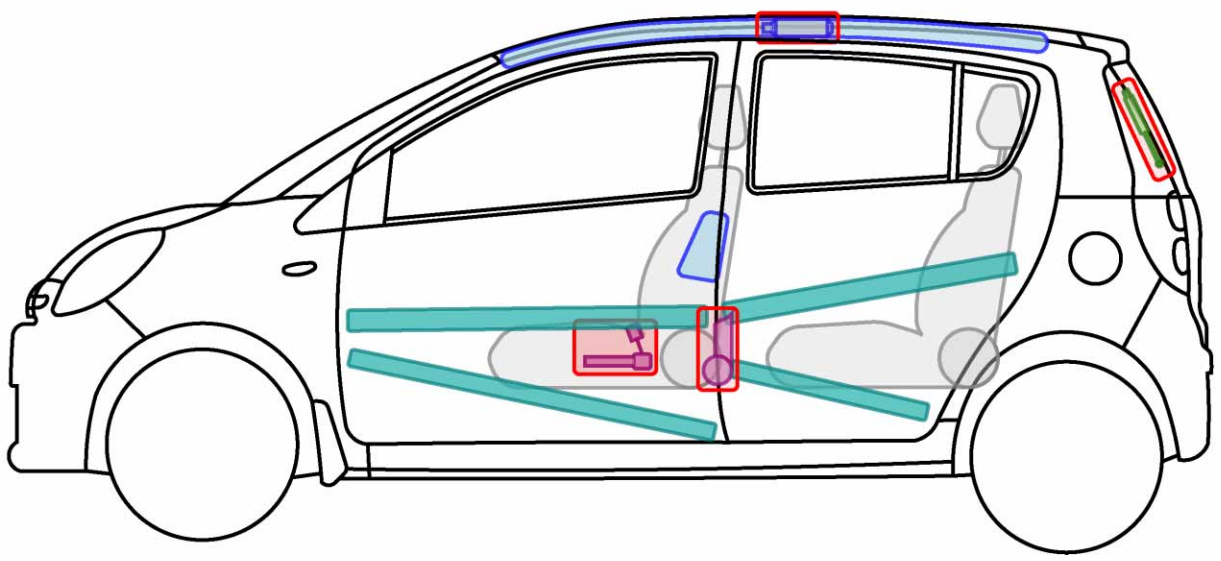
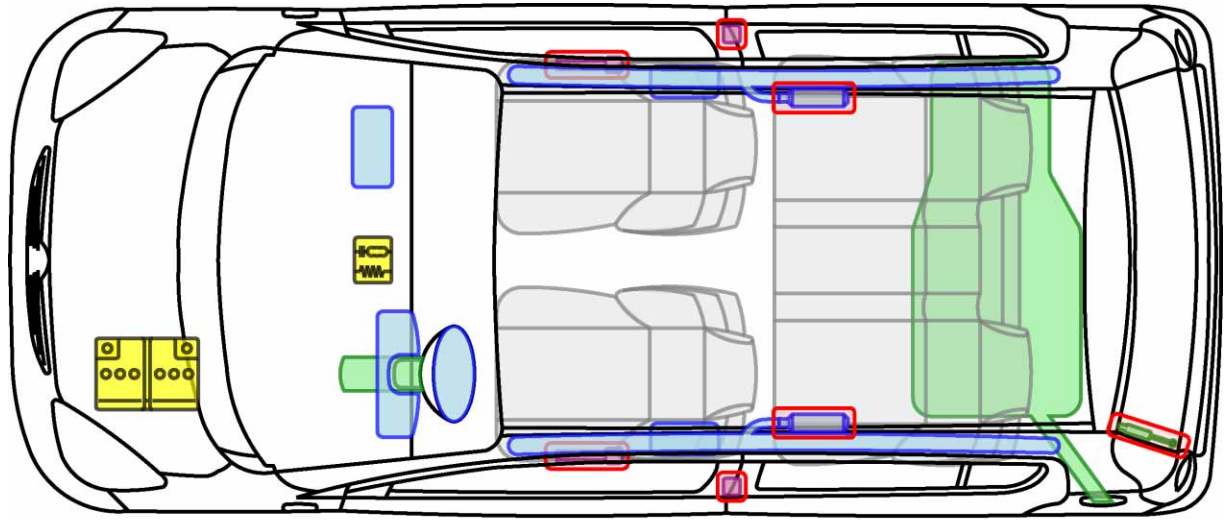

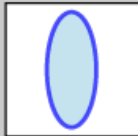

DAIHATSU
Die perfekte Grösse.

CUORE (L276) dal 2007

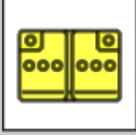

Legende

| | | | | | |
|---|---------------|---|------------------------|--|-----------------|
|  | Airbag |  | Karosserie-verstärkung |  | Steuergerät |
|  | Gas-generator |  | Überroll-schutz |  | Batterie |
|  | Gurt-straffer |  | Gasdruck-dämpfer |  | Kraftstoff-tank |

Cuore







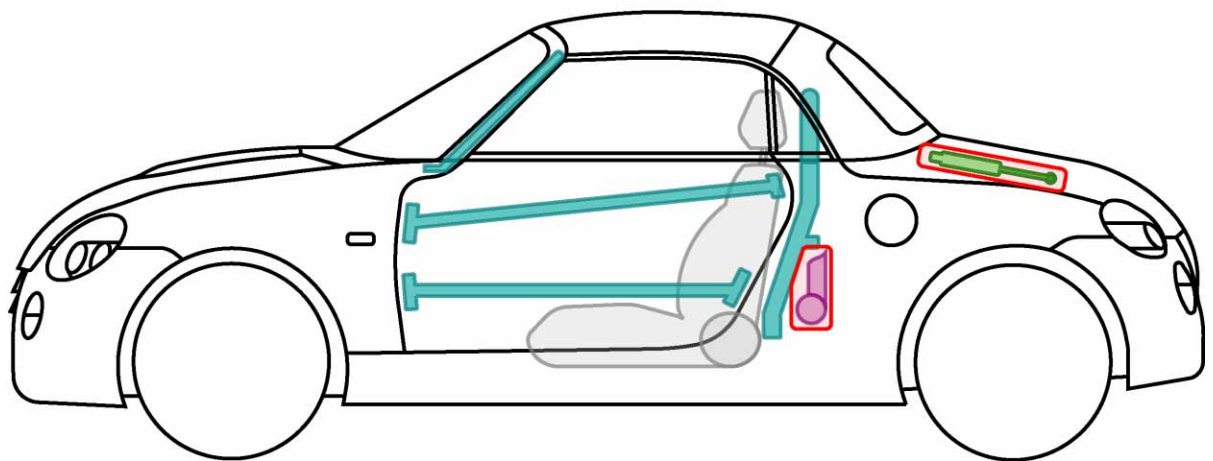
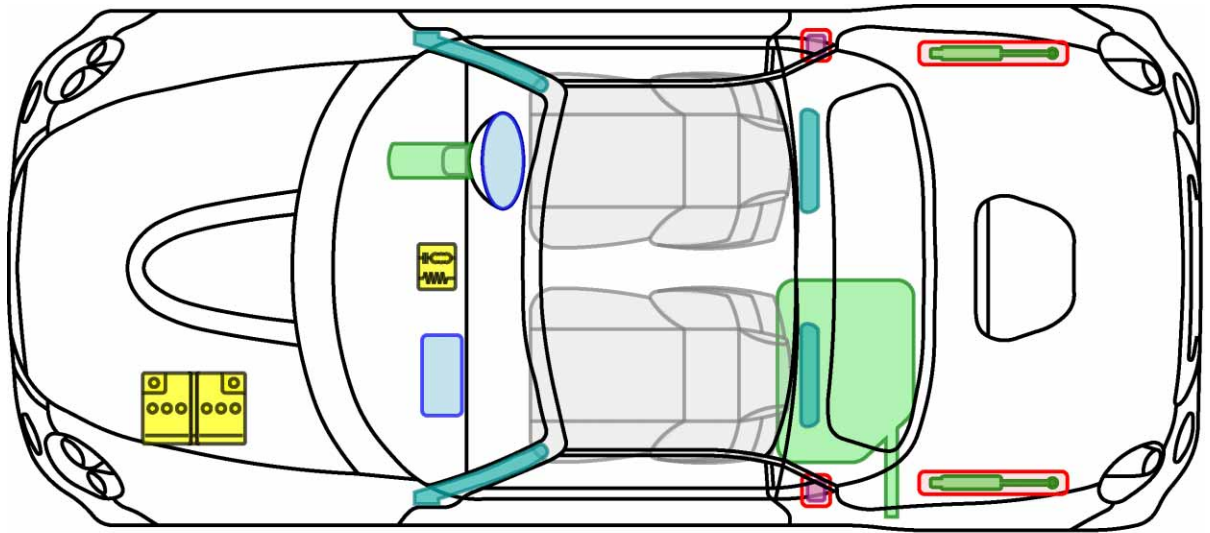

DAIHATSU

Die perfekte Grösse.

COPEN (L880) 2004-2006

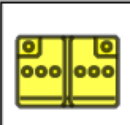
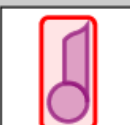

Legende

| | | | | | |
|---|-------------------|---|----------------------------|--|---------------------|
|  | Airbag |  | Karosserie- verstärkung |  | Steuergerät |
|  | Gas- generator |  | Überroll- schutz |  | Batterie |
|  | Gurt- straffer |  | Gasdruck- dämpfer |  | Kraftstoff- tank |

Copen







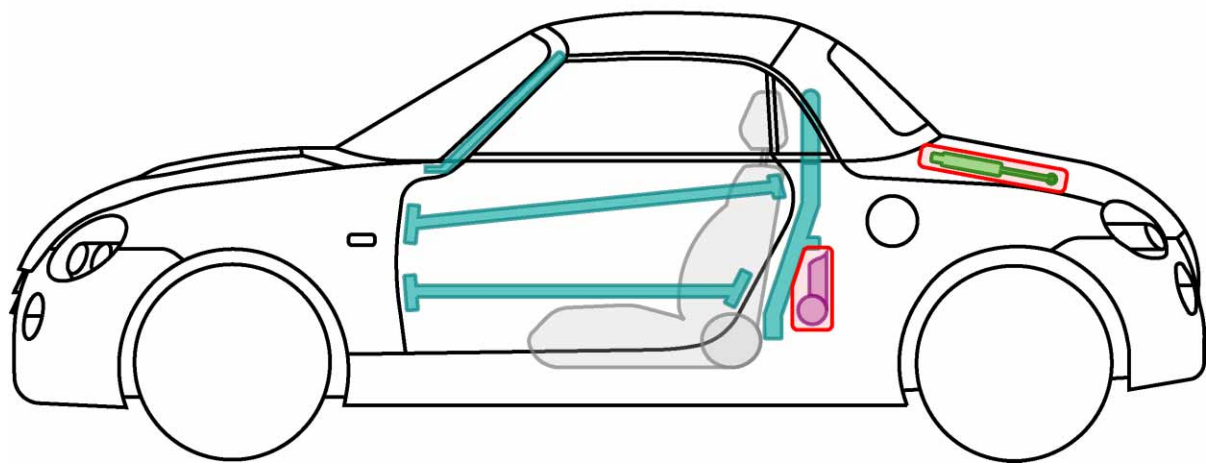
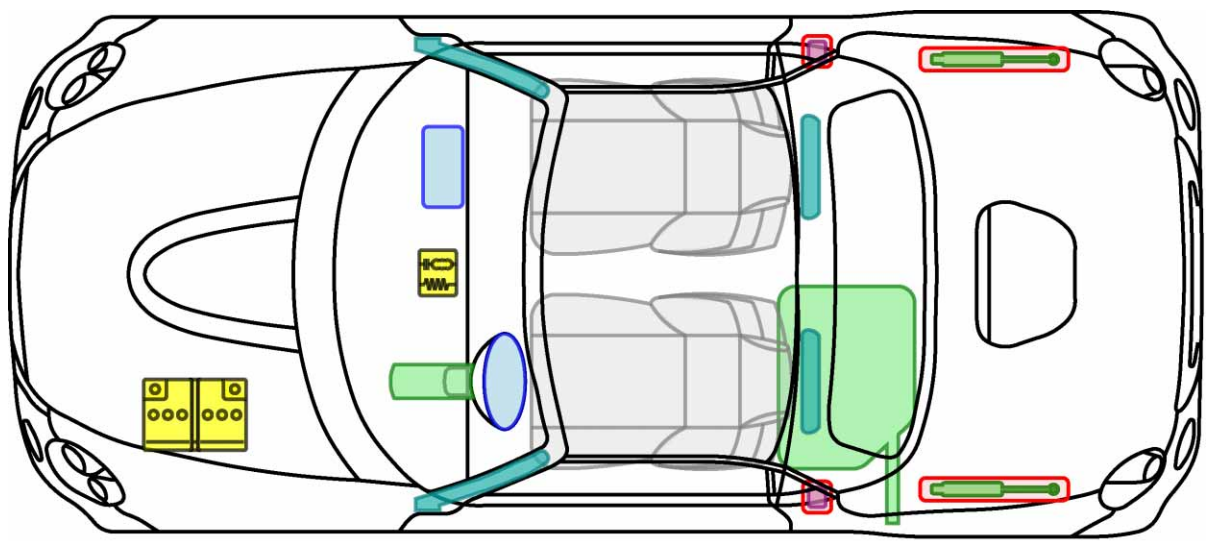

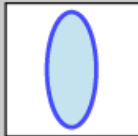

DAIHATSU
Die perfekte Grösse.

COPEN (L881) dal 2006

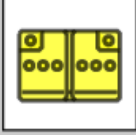

Legende

| | | | | | |
|---|---------------|---|------------------------|--|-----------------|
|  | Airbag |  | Karosserie-verstärkung |  | Steuergerät |
|  | Gas-generator |  | Überroll-schutz |  | Batterie |
|  | Gurt-straffer |  | Gasdruck-dämpfer |  | Kraftstoff-tank |

Copen







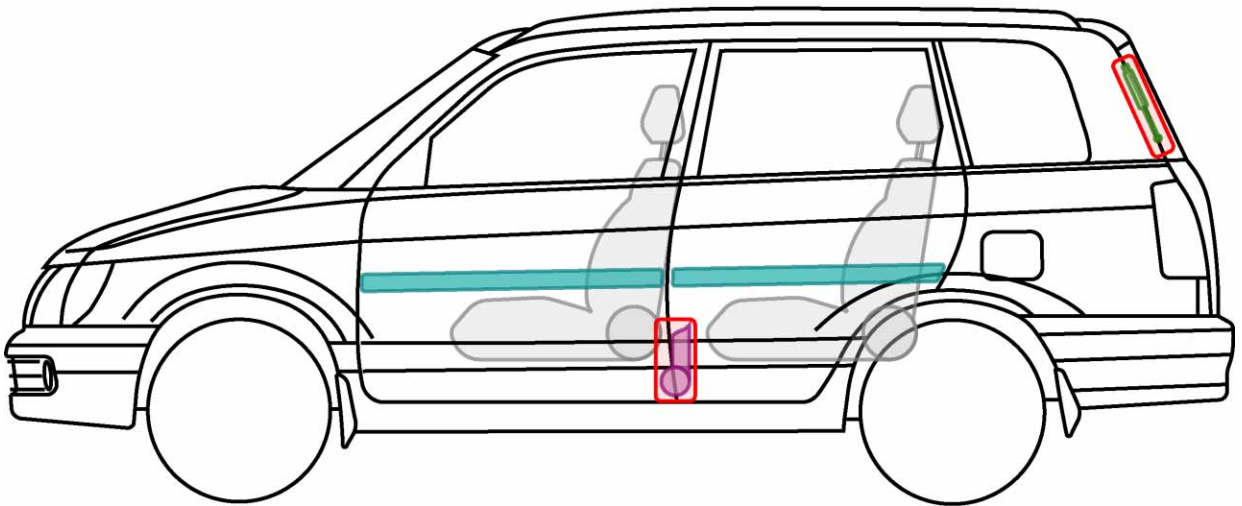
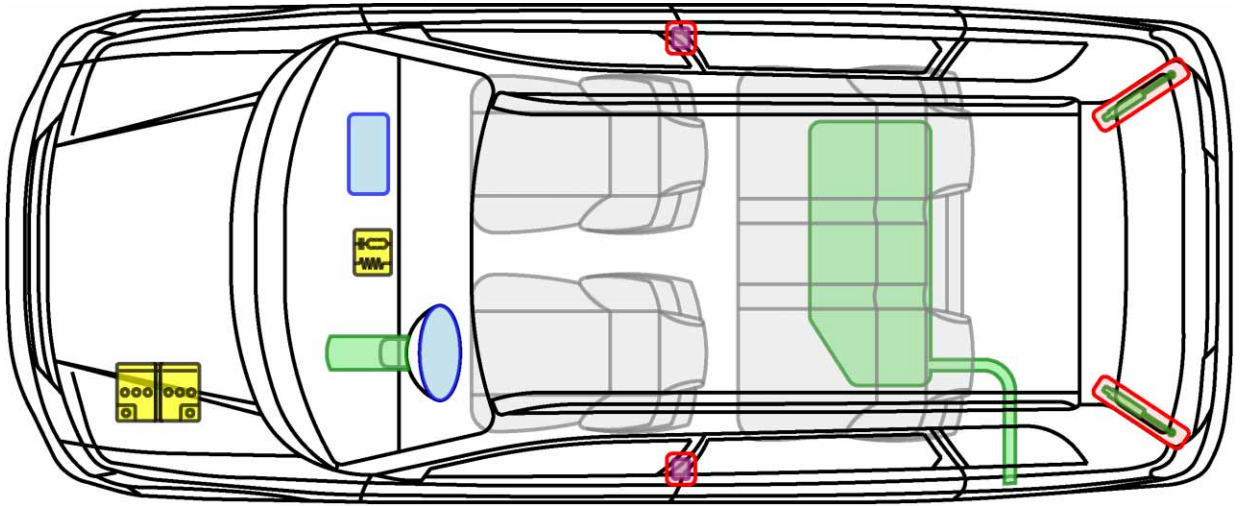

DAIHATSU

Die perfekte Grösse.

GRAN MOVE (G3) 1998-2003

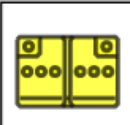
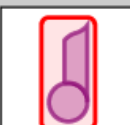

Legende

| | | | | | |
|---|-------------------|---|----------------------------|--|---------------------|
|  | Airbag |  | Karosserie- verstärkung |  | Steuergerät |
|  | Gas- generator |  | Überroll- schutz |  | Batterie |
|  | Gurt- straffer |  | Gasdruck- dämpfer |  | Kraftstoff- tank |

Gran Move



DAIHATSU

Die perfekte Grösse.

MATERIA (M4) dal 2007

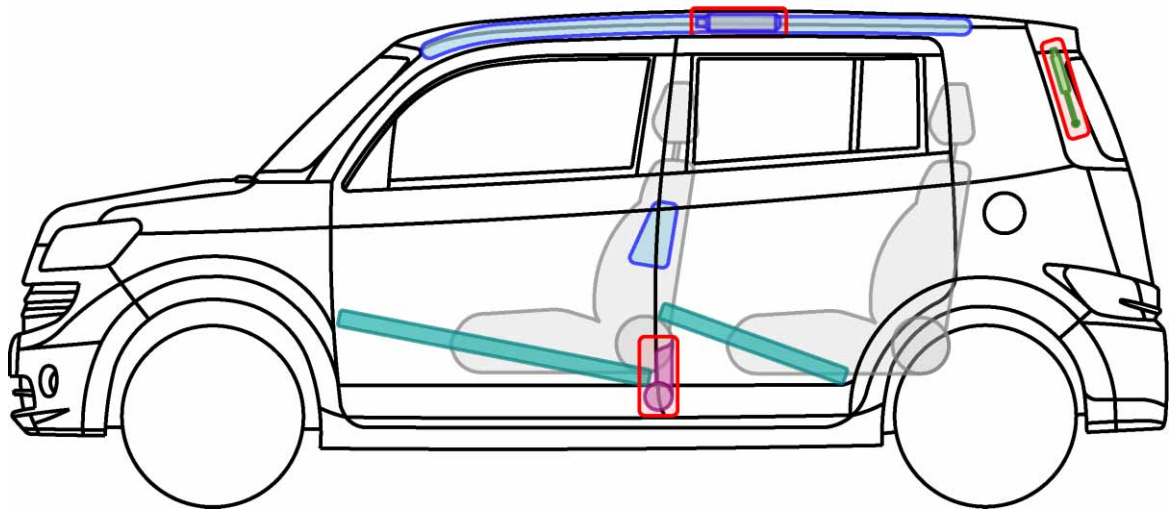
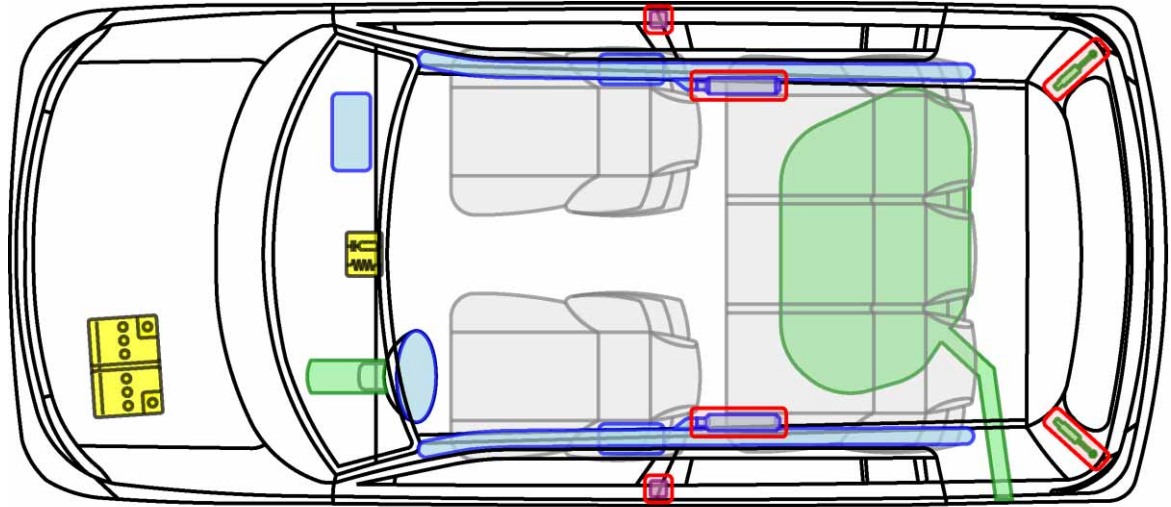

Legende

| | | | | | |
|--|---------------|--|------------------------|--|-----------------|
| | Airbag | | Karosserie-verstärkung | | Steuergerät |
| | Gas-generator | | Überroll-schutz | | Batterie |
| | Gurt-straffer | | Gasdruck-dämpfer | | Kraftstoff-tank |

Materia









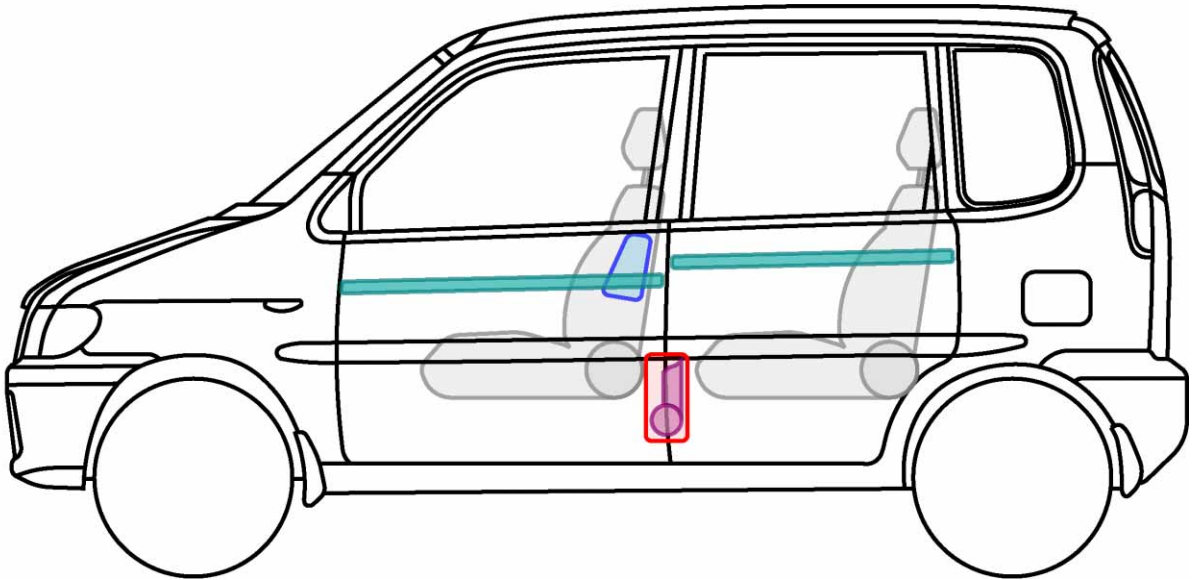
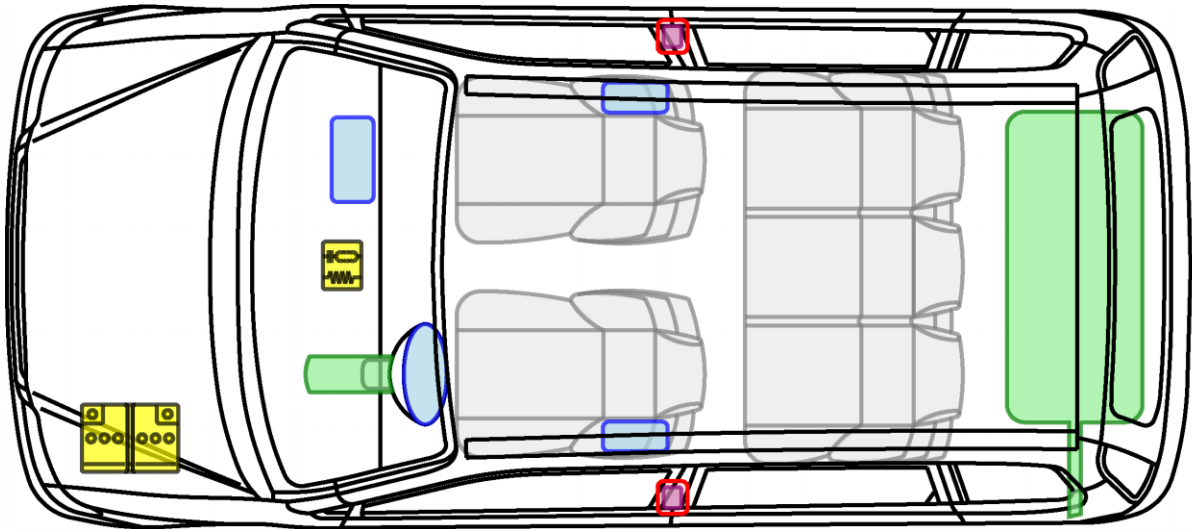

DAIHATSU

Die perfekte Grösse.

MOVE (L6/L9) 1997-2003

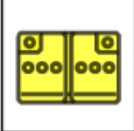

Legende

| | | | | | |
|---|---------------|---|------------------------|--|-----------------|
|  | Airbag |  | Karosserie-verstärkung |  | Steuergerät |
|  | Gas-generator |  | Überroll-schutz |  | Batterie |
|  | Gurt-straffer |  | Gasdruck-dämpfer |  | Kraftstoff-tank |

Move



DAIHATSU

Die perfekte Grösse.

SIRION (M1) 1998-2005

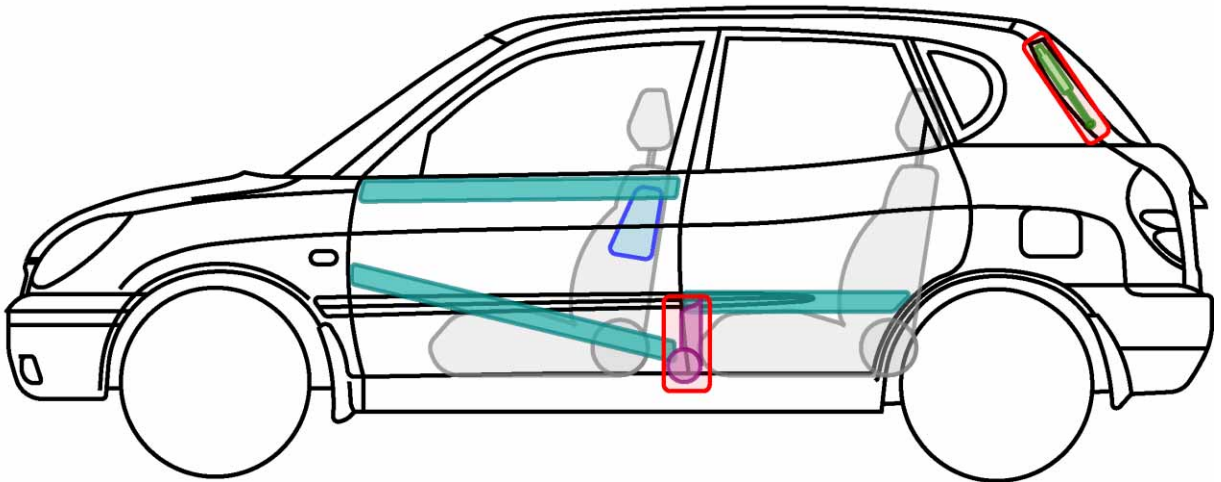
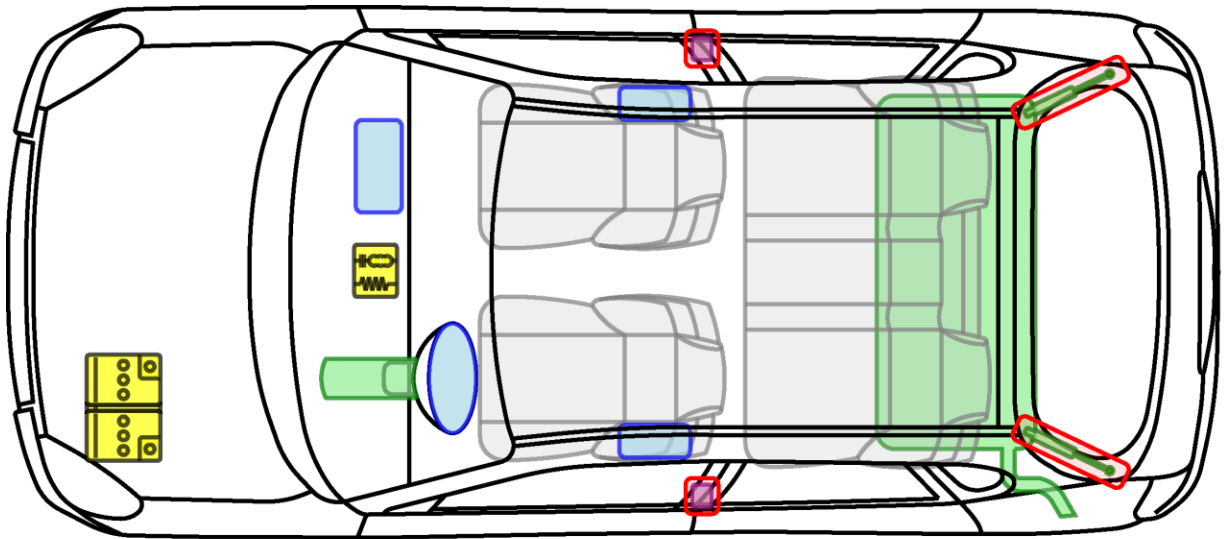

Legende

| | | | | | |
|--|-------------------|--|----------------------------|--|---------------------|
| | Airbag | | Karosserie- verstärkung | | Steuergerät |
| | Gas- generator | | Überroll- schutz | | Batterie |
| | Gurt- straffer | | Gasdruck- dämpfer | | Kraftstoff- tank |

Sirion







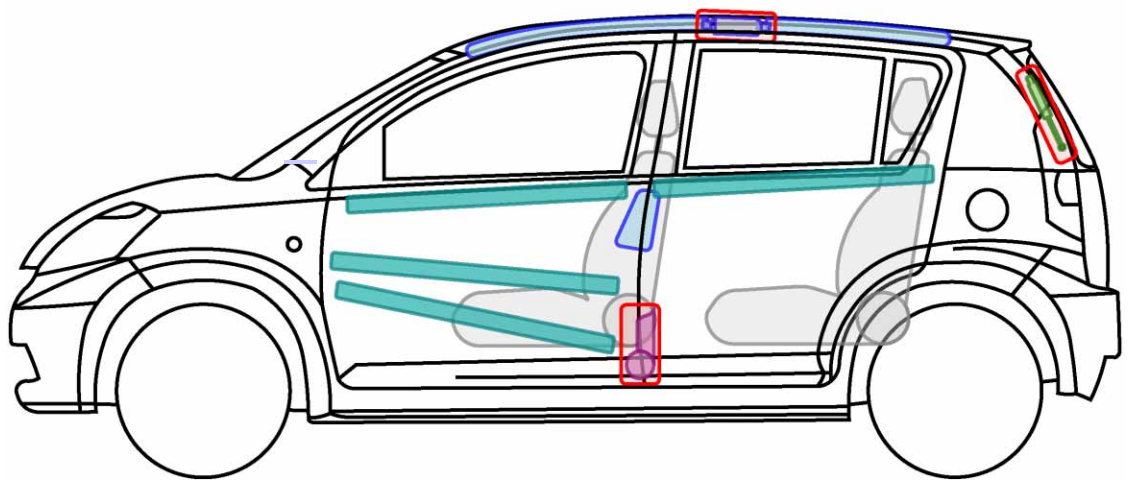
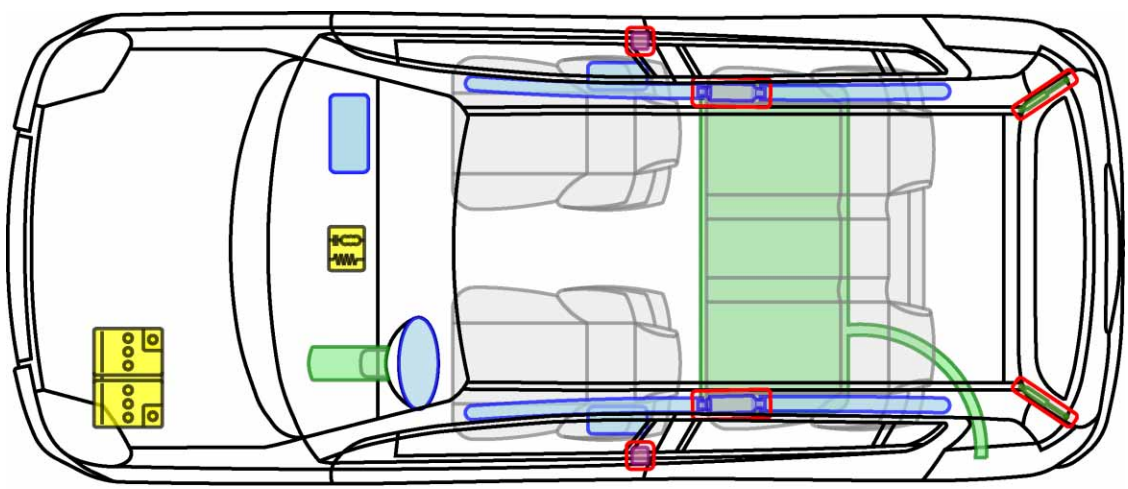

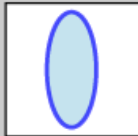

DAIHATSU
Die perfekte Grösse.

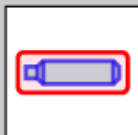
SIRION (M3) dal 2005

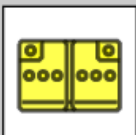

Legende

| | | | | | |
|---|---------------|---|------------------------|--|-----------------|
|  | Airbag |  | Karosserie-verstärkung |  | Steuergerät |
|  | Gas-generator |  | Überroll-schutz |  | Batterie |
|  | Gurt-straffer |  | Gasdruck-dämpfer |  | Kraftstoff-tank |

Sirion









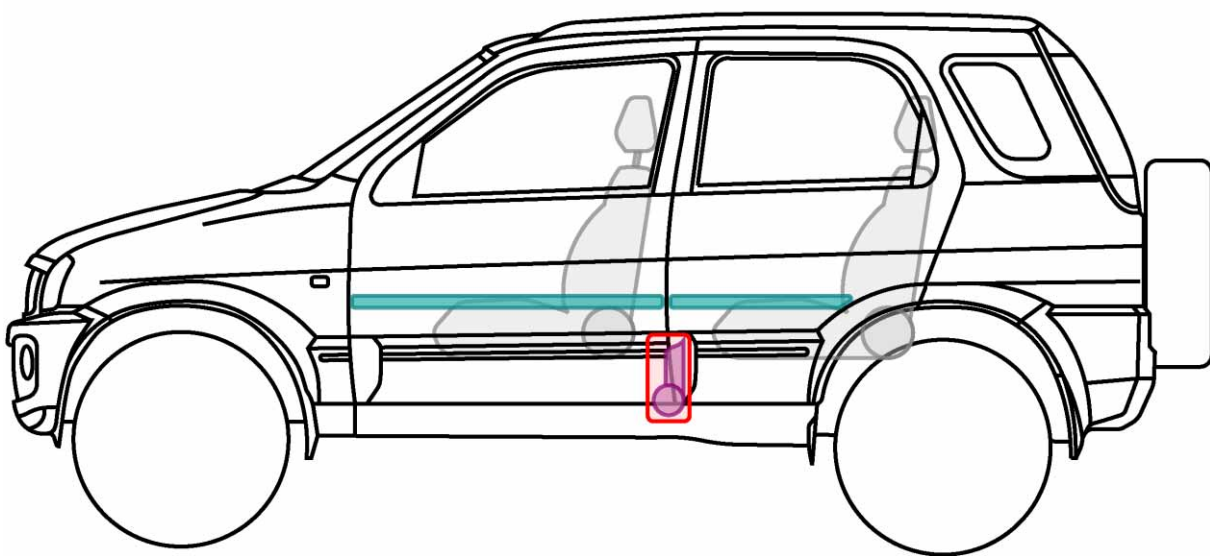
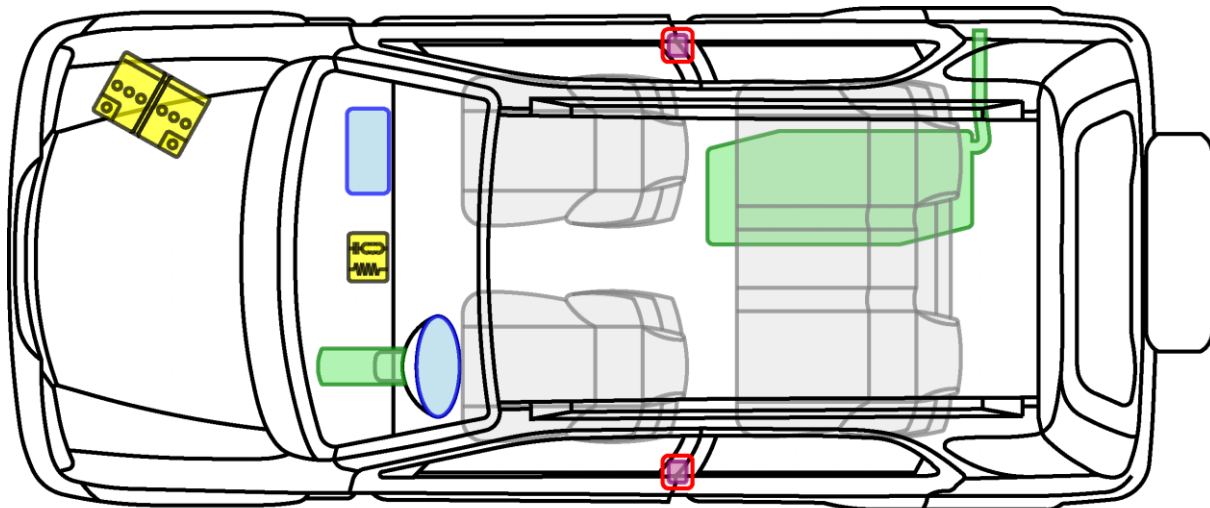

DAIHATSU

Die perfekte Grösse.

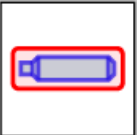
TERIOS (J1) 1997-2005

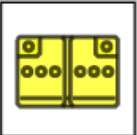

Legende

| | | | | | |
|---|---------------|---|------------------------|--|-----------------|
|  | Airbag |  | Karosserie-verstärkung |  | Steuergerät |
|  | Gas-generator |  | Überroll-schutz |  | Batterie |
|  | Gurt-straffer |  | Gasdruck-dämpfer |  | Kraftstoff-tank |

Terios



DAIHATSU

Die perfekte Grösse.

TERIOS (J2) dal 2006

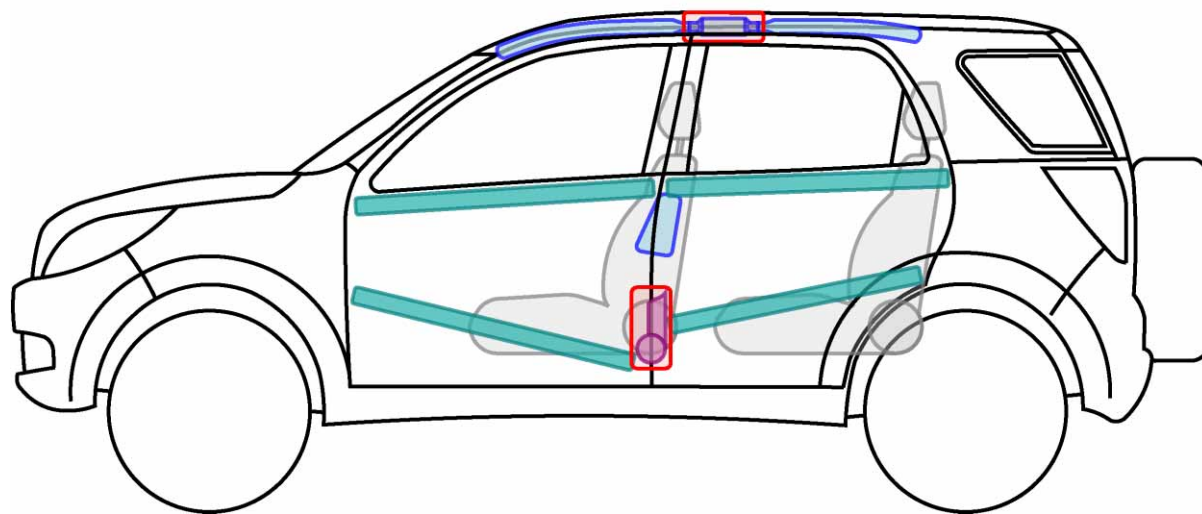
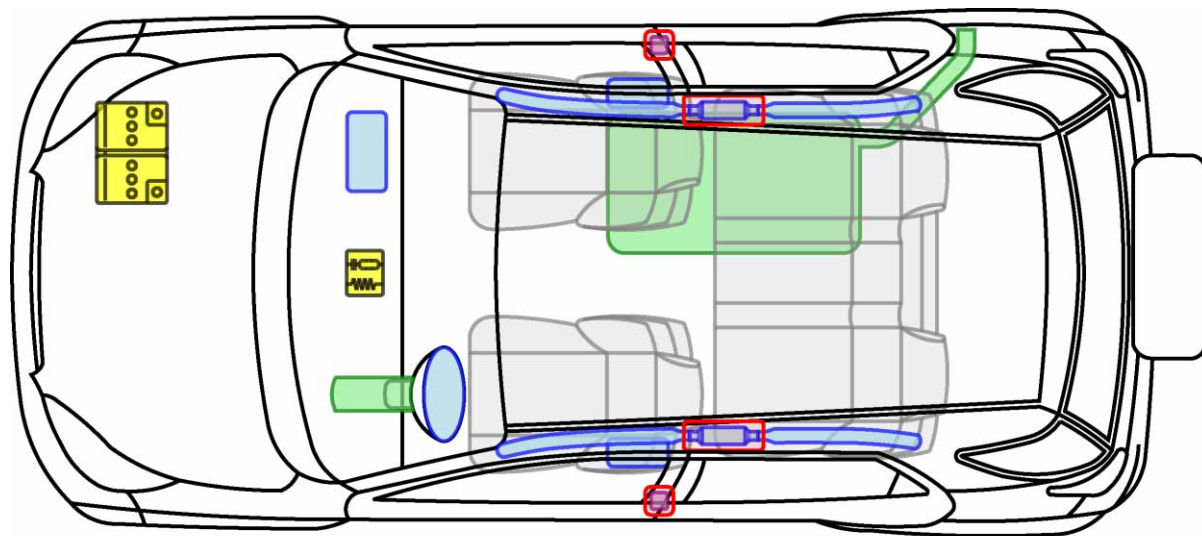

Legende

| | | | | | |
|--|---------------|--|------------------------|--|-----------------|
| | Airbag | | Karosserie-verstärkung | | Steuergerät |
| | Gas-generator | | Überroll-schutz | | Batterie |
| | Gurt-straffer | | Gasdruck-dämpfer | | Kraftstoff-tank |

Terios









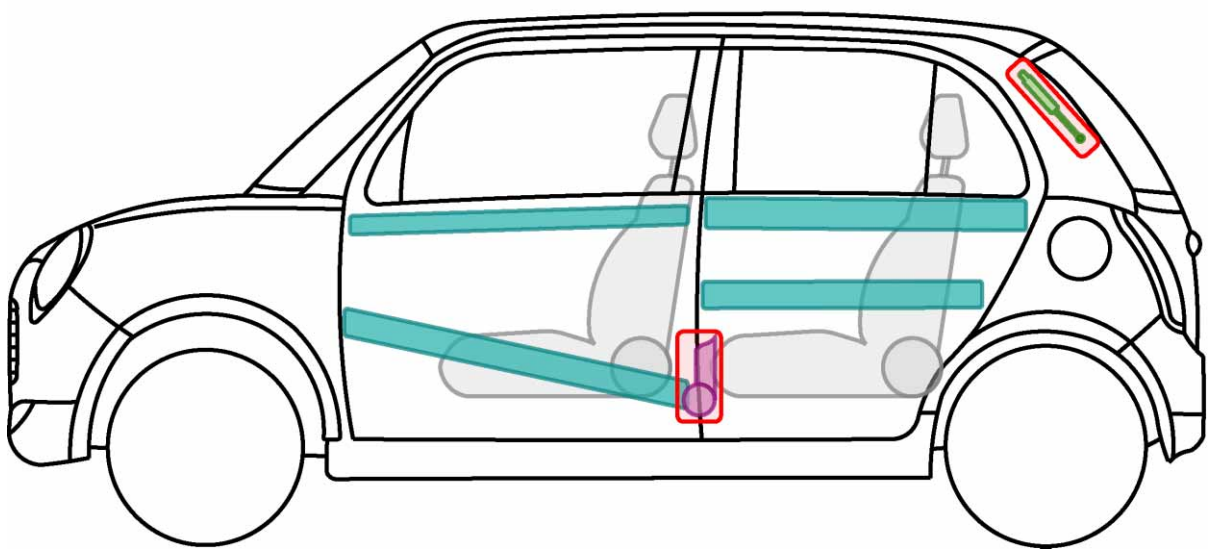
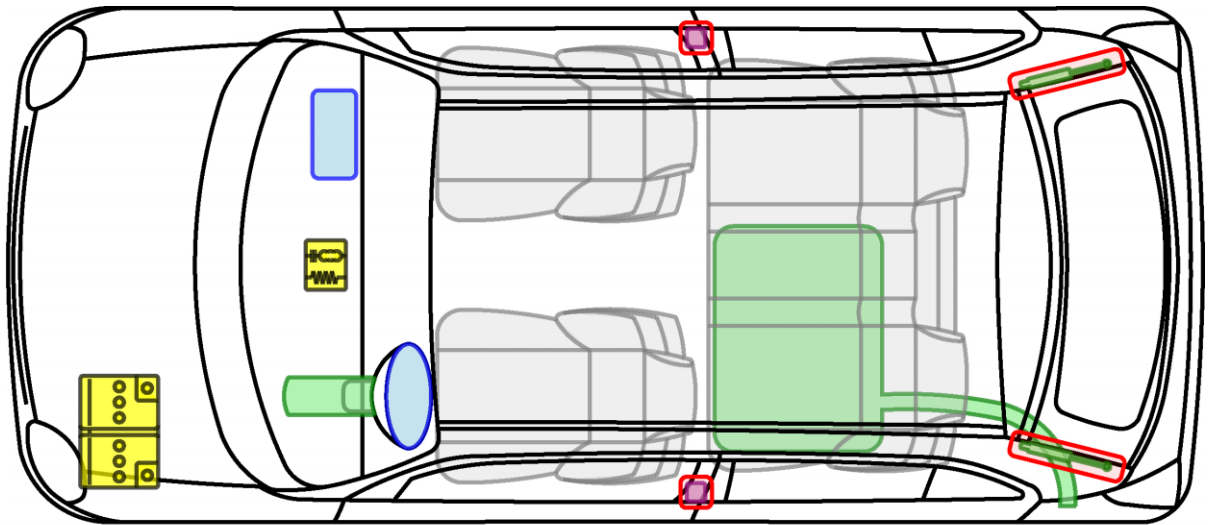

DAIHATSU

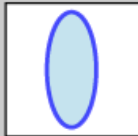
Die perfekte Grösse.

TREVIS (L651) 2006-2009

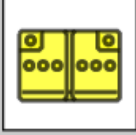

Legende

| | | | | | |
|---|---------------|---|------------------------|--|-----------------|
|  | Airbag |  | Karosserie-verstärkung |  | Steuergerät |
|  | Gas-generator |  | Überroll-schutz |  | Batterie |
|  | Gurt-straffer |  | Gasdruck-dämpfer |  | Kraftstoff-tank |

Trevis







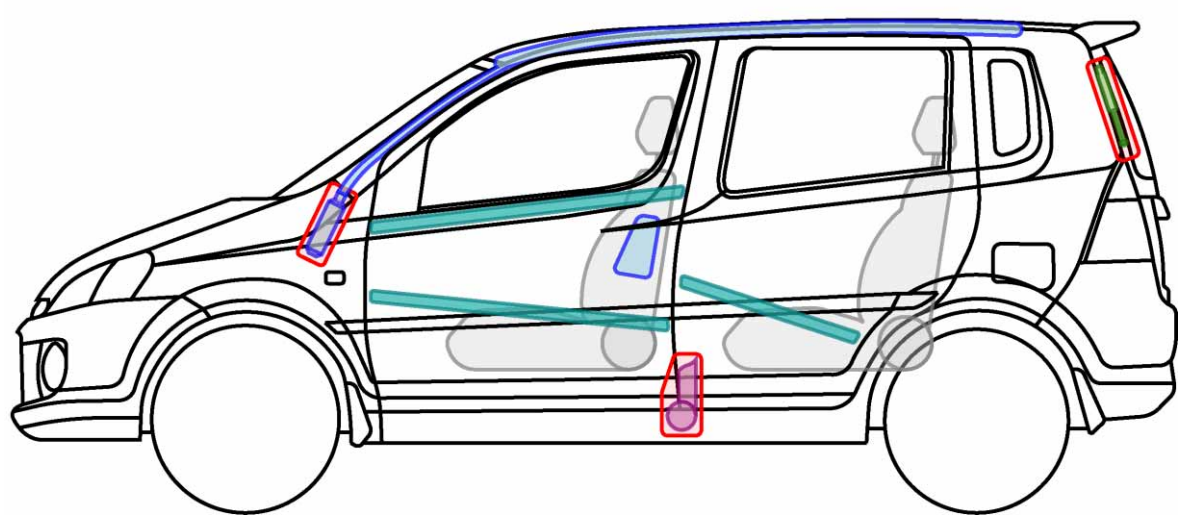
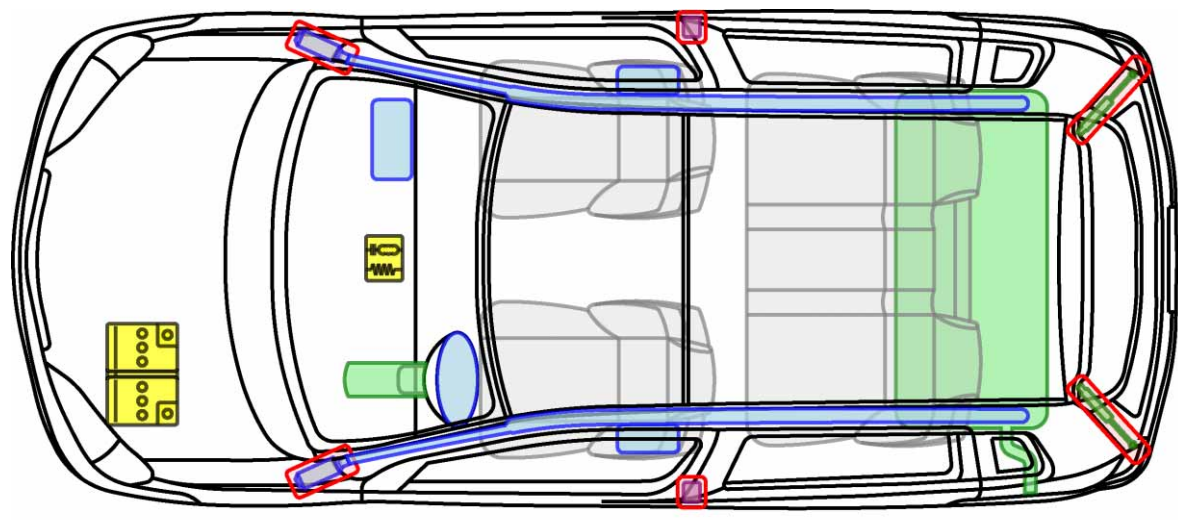

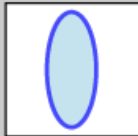

DAIHATSU
Die perfekte Grösse.

YRV (M2) 2005-2007

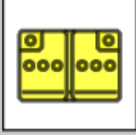

Legende

| | | | | | |
|---|---------------|---|------------------------|--|-----------------|
|  | Airbag |  | Karosserie-verstärkung |  | Steuergerät |
|  | Gas-generator |  | Überroll-schutz |  | Batterie |
|  | Gurt-straffer |  | Gasdruck-dämpfer |  | Kraftstoff-tank |

YRV

