

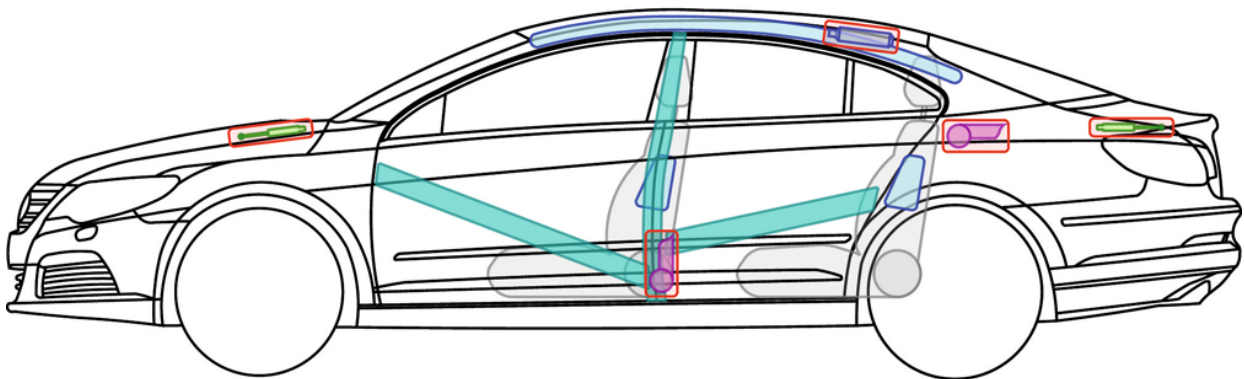

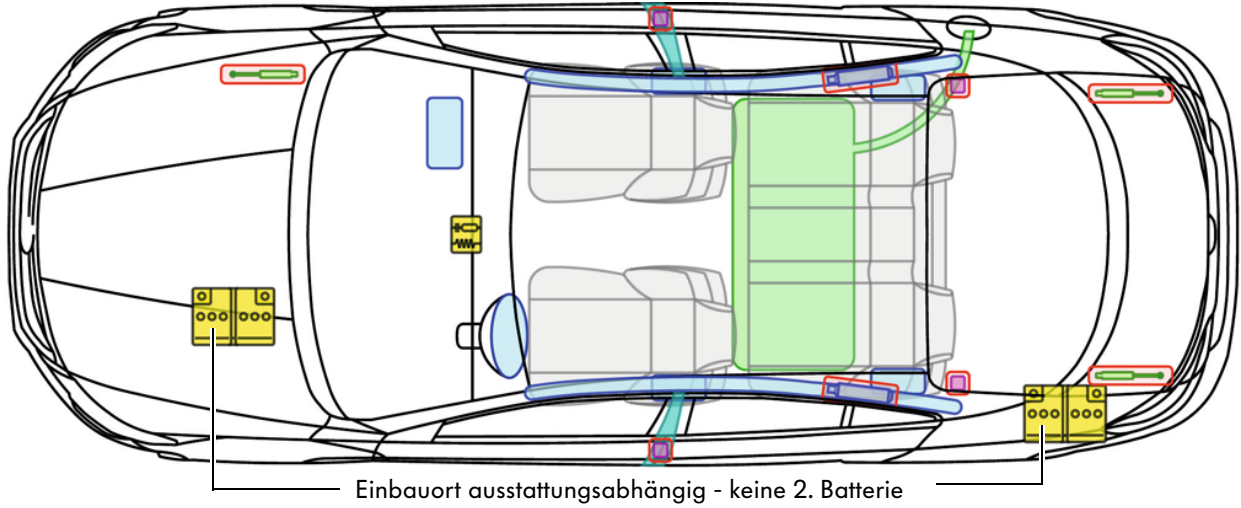







Passat CC (ab 2008)



Legende

	Airbag		Karosserie-Verstärkung		Steuergerät
	Gas-generator				12V-Batterie
	Gurtstraffer		Gasdruck-dämpfer		Kraftstofftank



Passat CC (ab 2008)



Fahrzeug deaktivieren

Batterie abklemmen (bei Einbauort Kofferraum)



1. Batterieabdeckung im Kofferraum entfernen

- Batterieabdeckung im Kofferraum auf der linken Fahrzeugseite lokalisieren
- Befestigungsschrauben lösen und Abdeckung abnehmen



2. Masseanschluss (-) an der Batterie abklemmen

P

Passat CC (ab 2008)