

FORD SERVICE

Rettungsdatenblätter

FORD **Ka+**

05/2016 – >



E235716

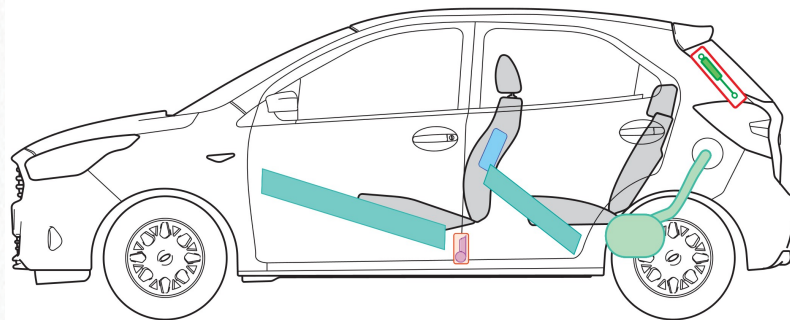
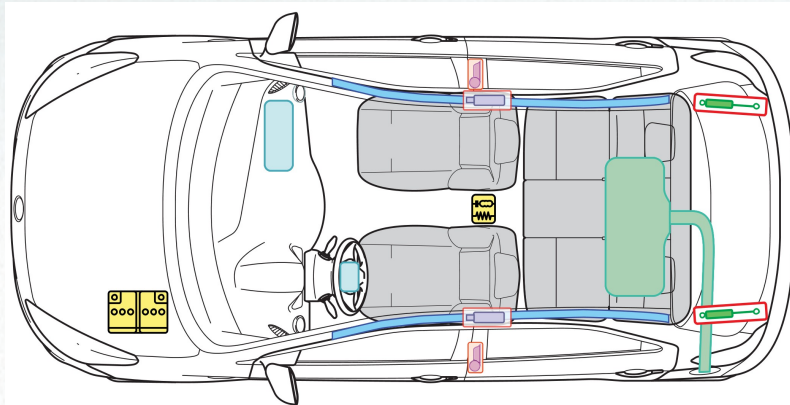

E235715

Legende

K

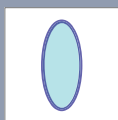

Airbag

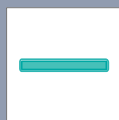

Karosseriever-
stärkung



Steuergerät



Fussgänger-
schutzsystem

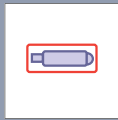

Gasgenerator



Überrollschutz-
bügel

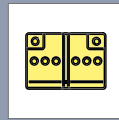

Batterie

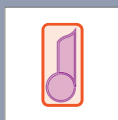

Gurtstraffer



Gasdruck-
dämpfer



Kraftstofftank

(Stand : 10/2016)

